



# SLICKLINE ASSISTANT WORKBOOK

**IMPORTANT NOTE:**

1. Your point of reference to complete this workbook may be obtained from the following
  - Training Manual and any other training materials provided together with this workbook
  - Your Trainer, Assessor (Slickline Operator), Verifier (FSM) or senior colleagues
  - SOP / Quality Procedures & Processors
2. The completion of this Workbook is a joint effort and responsibility between you and your assessor therefore you have the obligation to request from your assessor to be assessed upon your completion of each topic
3. The completion of this Workbook is part of the MANDATORY requirements which you must fulfill to qualify for a promotion
4. Your training program is mostly self-driven, including this Workbook. It requires individual initiatives, dedication and commitment to complete the process.

NAME	MUHAMMAD HAHMI BIN SHAMSUL BAHRI
DATE OF JOIN	04/07/2022
CONTACT NO.	018-9704660
RECEIVED DATE	04/07/2022
DATE COMPLETED	23/08/2023



**B. SURFACE EQUIPMENT**

**1. Stuffing Box**

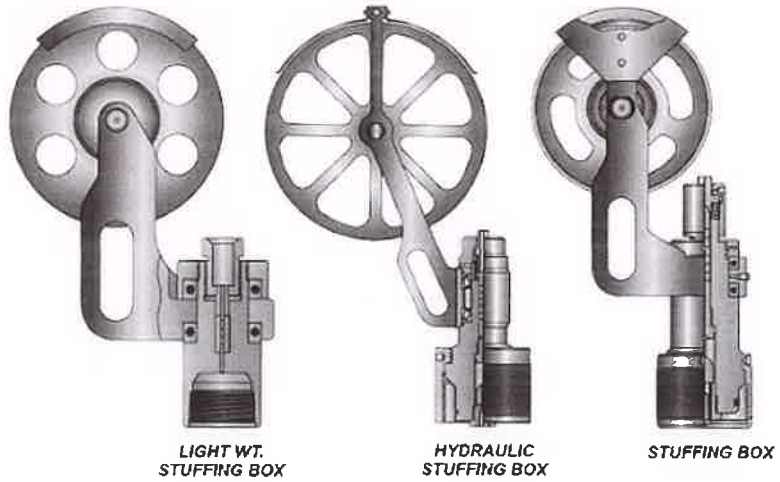

What is Stuffing Box

- ✓ - Stuffing box is a sealing device connected to the top of lubricator section
- ✓ - Guide solid wire line go through into the well

What is the purpose of stuffing Box

- ✓ Stuffing box is to ensure containment or sealing off around solid wireline, weather stationary or in motion at the upper end off the lubricator during wireline operation

How to operate Stuffing Box

- ✓ Stuffing box can be operated either manually or hydraulically without part modification.

What is maintenance required for Stuffing Box

- ✓ - General damage
- ✓ - check to condition O-ring groove
- ✓ - check upper and lower gland
- ✓ - Change packing

What is safety precaution required for Stuffing Box

- ✓ - make sure collar has been tight
- ✓ - make sure pressure zero before break off the collar
- ✓ - use proper tool

*[Handwritten signature]*  
2/8/23

What is potential hazard during handling Stuffing Box

- ✓ Back injury
- ✓ Finger pinch.

Draw & name each part of stuffing box

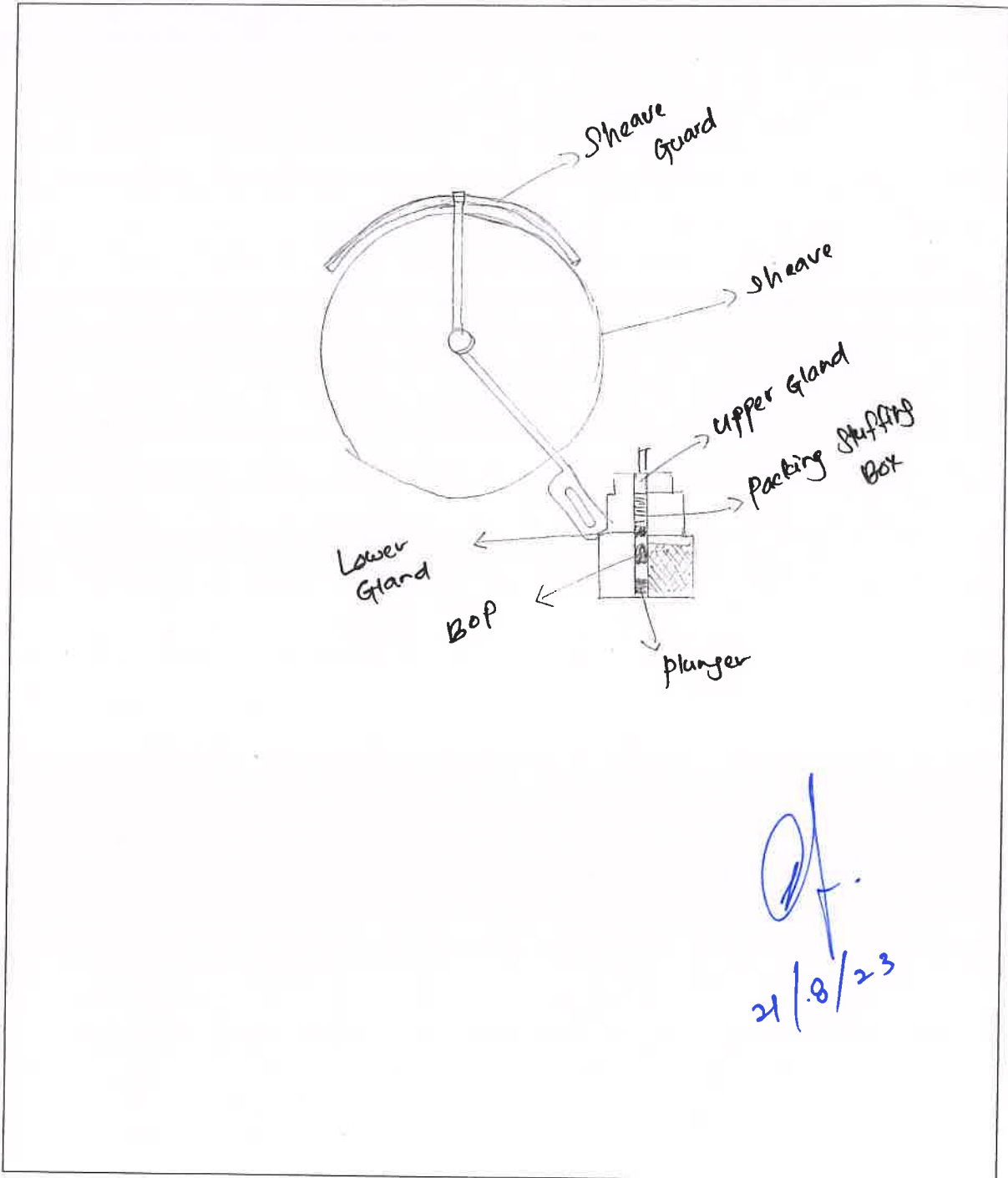

*[Signature]*  
21/8/23



2. Lubricator

What is Lubricator

- ✓ Lubricator is a pressure vessel situated above the Christmas tree, subject to the well head shut-in pressure and tests pressures.

What is the purpose of Lubricator

- ✓ Lubricator allows wireline tool to enter or be removed from the well under pressure.

How to operate Lubricator

- ✓ - connect box up and pin
- ✓ - make sure O ring in good condition

What is maintenance required for Lubricator

- ✓ - change O' ring, pin, external thread, stainless band, box and valve.
- ✓ - check general damage
- ✓ - put grease on thread.

What is safety precaution required for Lubricator

- ✓ - make sure collar has been tight
- ✓ - make sure O' ring in good condition

What is potential hazard during handling Lubricator

- ✓ - Finger and hand injury
- ✓ - Back pain
- ✓ - wrong techic

  
21/8/23



Draw & name each part of Lubricator

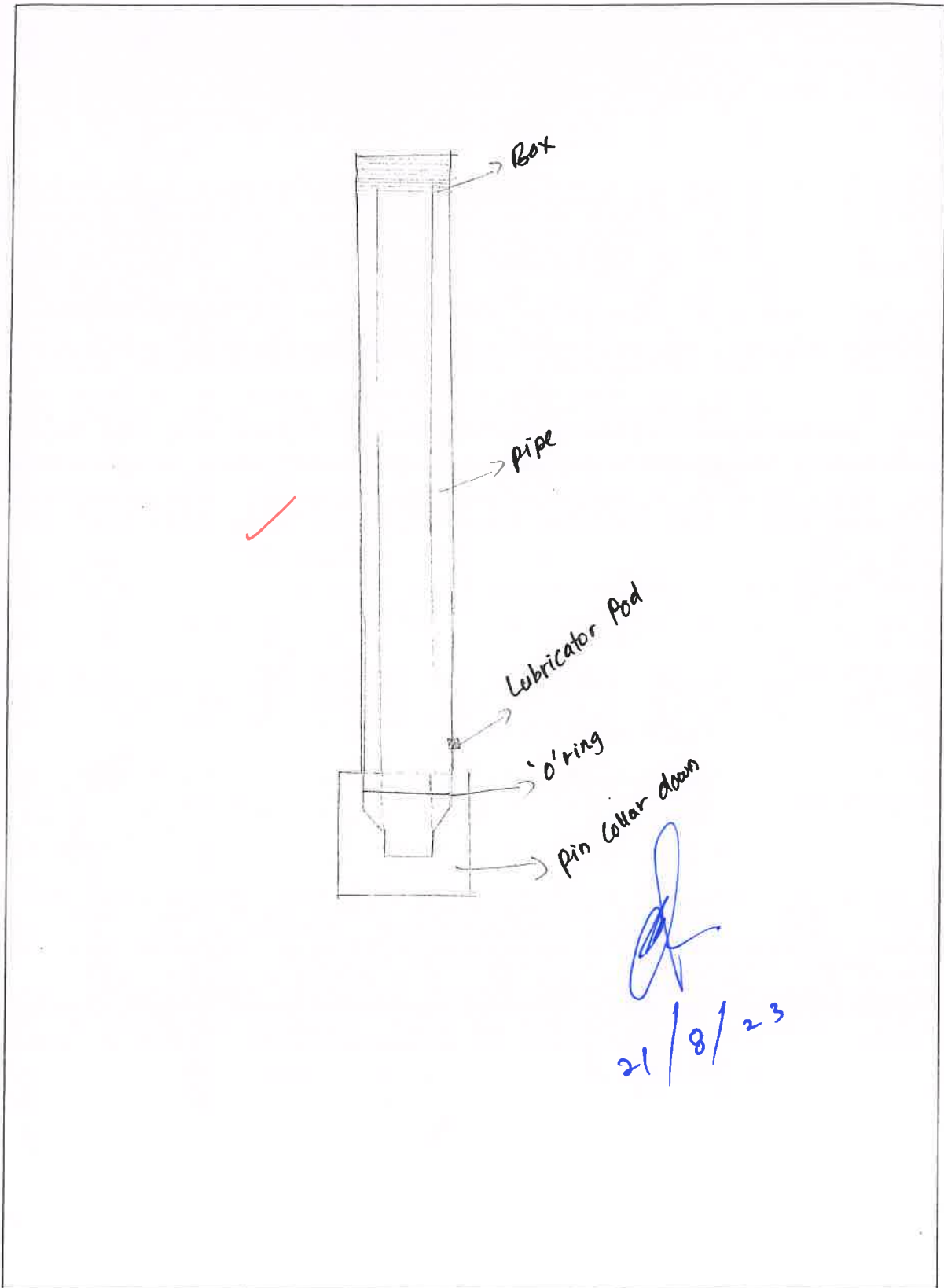



3. Blowout Preventer (BOP)

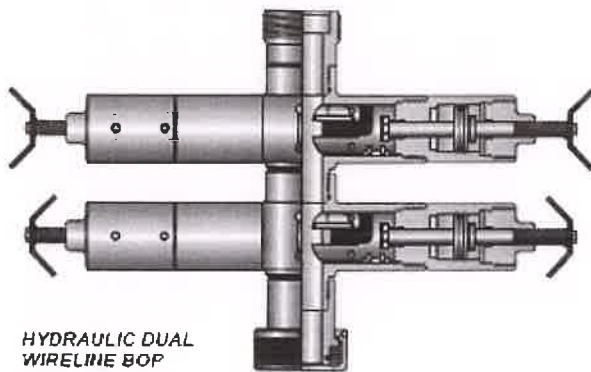

HYDRAULIC DUAL WIRELINE BOP

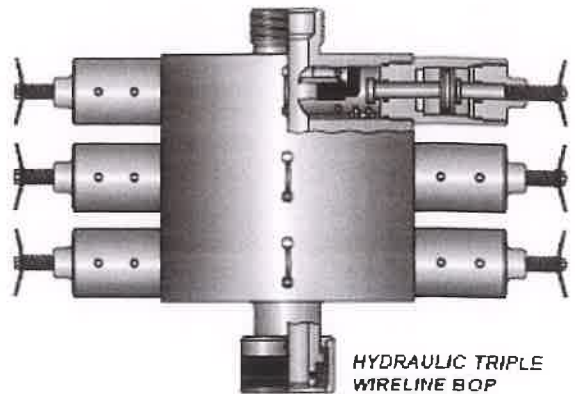

HYDRAULIC TRIPLE WIRELINE BOP

What is BOP

✓ A Blow out preventer (Bop) is a large, specialized valve or similar mechanical device, used to seal, control and monitor oil and gas well to prevent blow out uncontrolled release of the well.

What is the purpose of BOP

✓ - To enable well pressure to be isolated with out cutting wire.  
✓ - To permit dropping at wireline cutter if the tool string become stuck in the well.

How to operate BOP

✓ - mechanical or hydraulic force is applied to close the rams which seal around the wire.

What is maintenance required for BOP

✓ - Changing O ring - Function test equalizing port  
✓ - Greasing  
✓ - Function test Bop rams

What is safety precaution required for BOP

✓ - Ensure while handling BOP part make sure use a proper method.

  
21/8/23



What is potential hazard during handling BOP

- manual handling
- pinch point

Draw & name each part of BOP

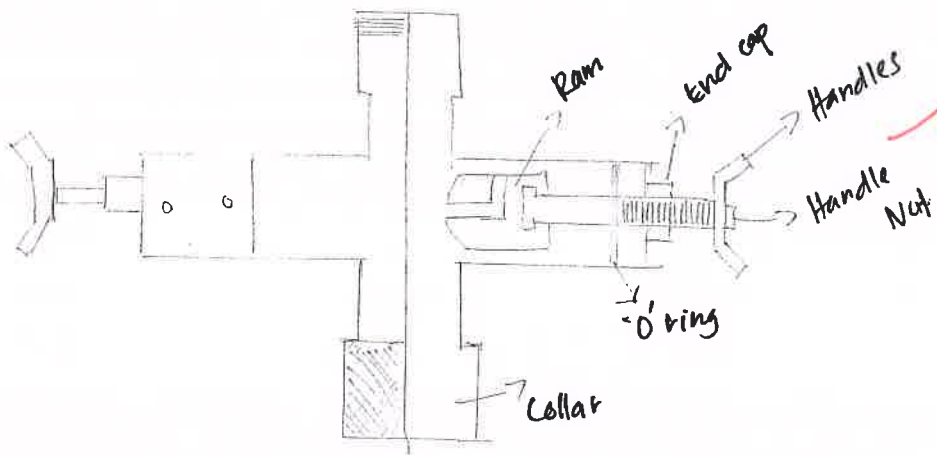

*[Signature]*  
21/8/23



4. X-Mas Tree

What is x-mas tree

✓ x-mas tree is a valve installed on to control the flow of fluid from well

What is the purpose of x-mas tree

✓ To control flow off and gas from well  
✓ safety barrier

How to operate x-mas tree

✓ use control panel for operate  
✓ By closing or opening swab valve and ssv to isolate

What is maintenance required for x-mas tree

✓ inspect gate valve condition  
✓ Greasing on well head valve

What is safety precaution required for x-mas tree

✓ Count to turn during close or open the valve  
✓ Do not over tighten during opening or closing

What is potential hazard during handling x-mas tree

✓ Blow out  
✓ Pressure trap  
✓ High pressure

  
21/8/23



Draw & name each part of x-mas tree

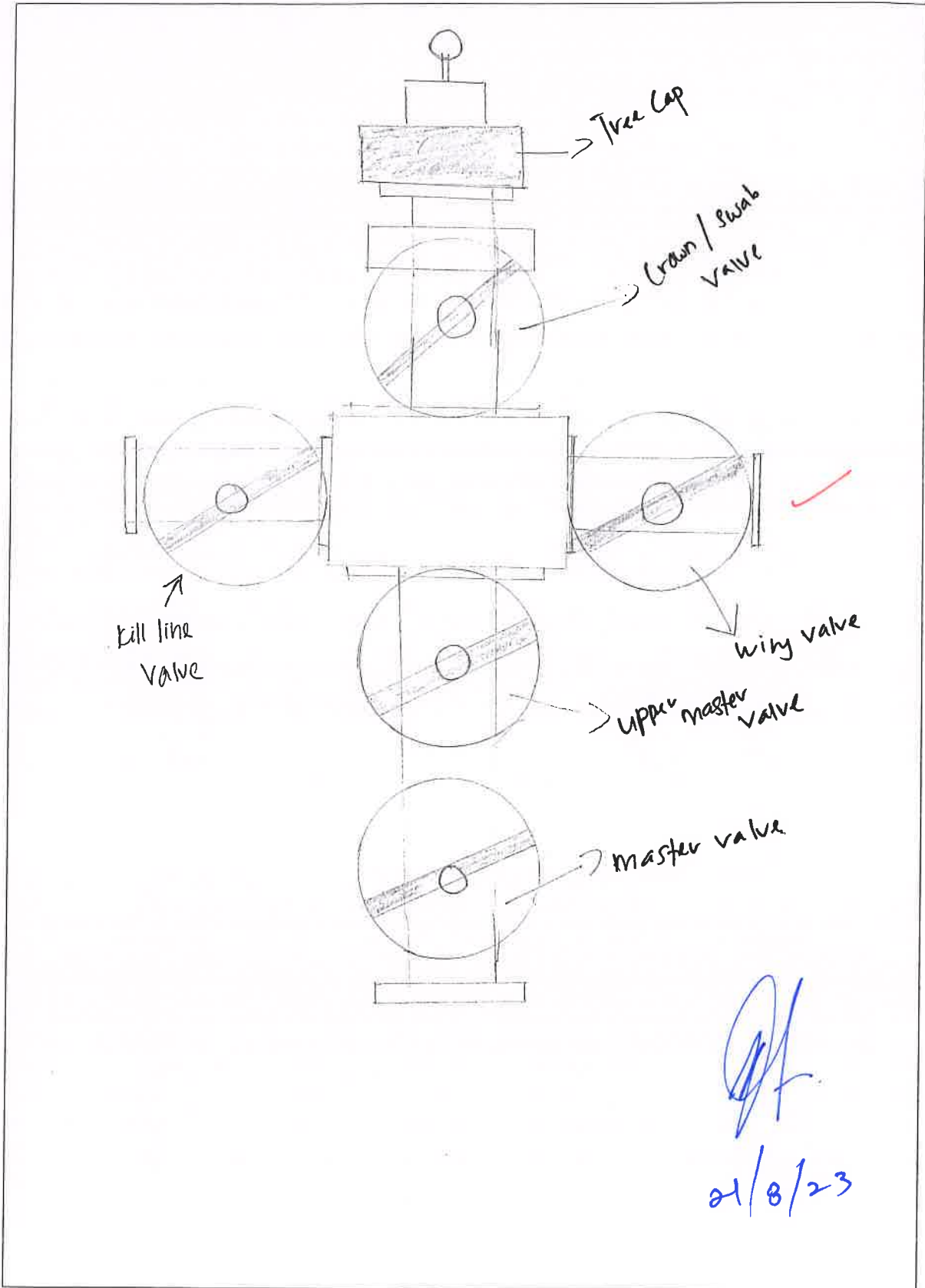



5. Wireline Reel Skid Unit (RSU) / Winch – Single Drum and Double Drum

What is RSU

- ✓ - RSU is device that use to control movement of the drum

What is the purpose of RSU

- ✓ - To deliver and retriwer tool down hole by using slickline wire

How to operate RSU

- ✓ - operate by power pack
- ✓ - manual control gear and valve

What is maintenance required for RSU

- ✓ - check gear box condition
- ✓ - hydraulic hose good condition
- ✓ - visual check on body part and frame
- ✓ - Greasing

What is safety precaution required for RSU

- ✓ - moving part
- ✓ - make sure connection hose is tighted
- ✓ - use whip check
- ✓ - make sure no leak on hose

What is potential hazard during handling RSU

- ✓ - Hose burst
- ✓ - manual handling
- ✓ - moving part
- ✓ - pinch point

  
21/8/23



Draw & name each part of RSU

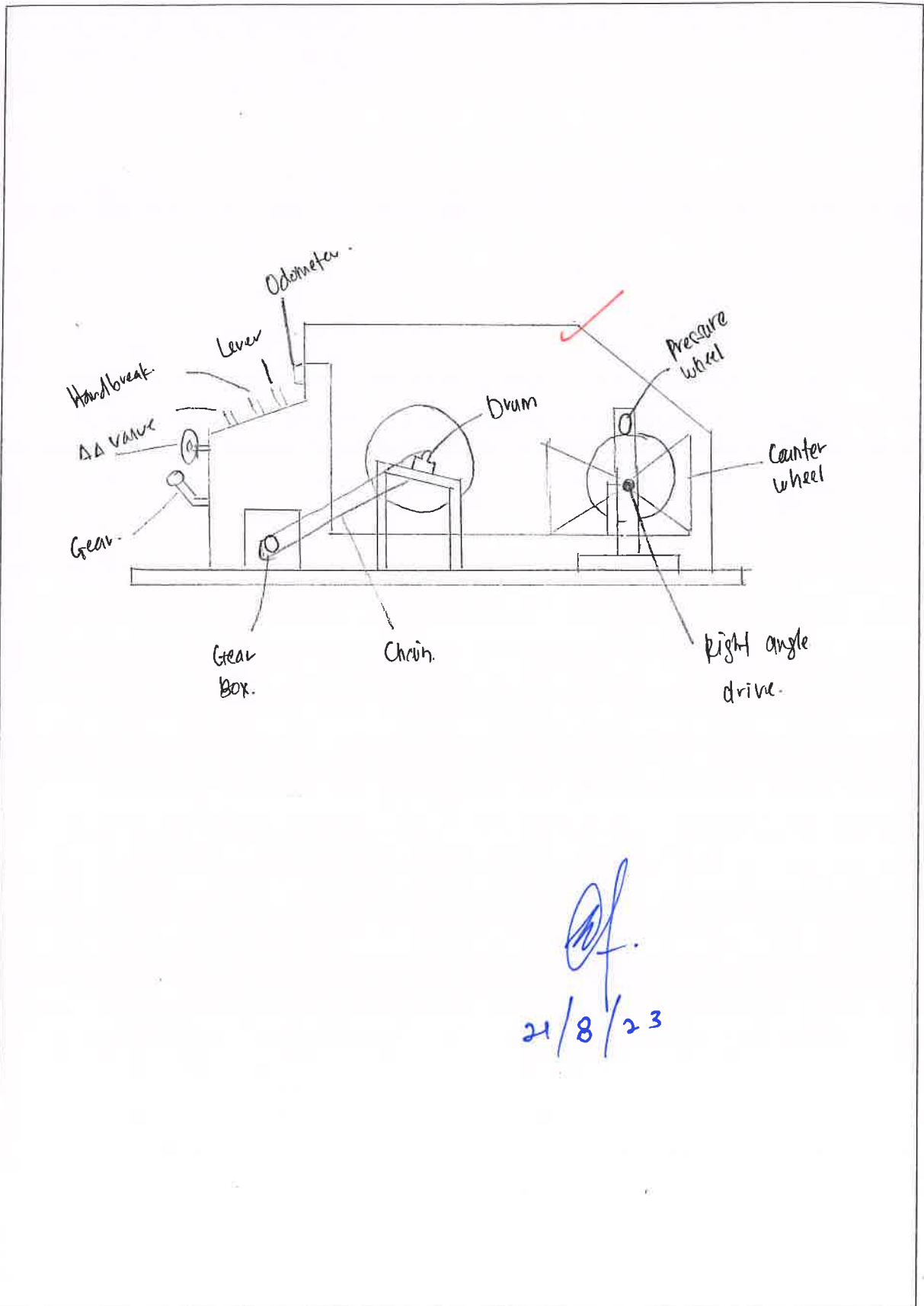

*[Signature]*  
21/8/23



6. Odometer

What is Odometer

- Odometer use to measuring depth inside the well.

What is the purpose of Odometer

- For operator look depth well and know about depth in well

How to operate Odometer

- Can be operated when connect odometer cable to the right angle drive. Right angle drive connect to counter wheel and odometer perform when counter wheel start spinning

What is maintenance required for Odometer

- Greasing gear inside

What is safety precaution required for Odometer

- make sure odometer number can readable  
- pin broken

What is potential hazard during handling Odometer

- Break the glass odometer  
- wrong depth (not accurate reading)  
- Finger injury

  
21/8/23



Draw & name each part of Odometer

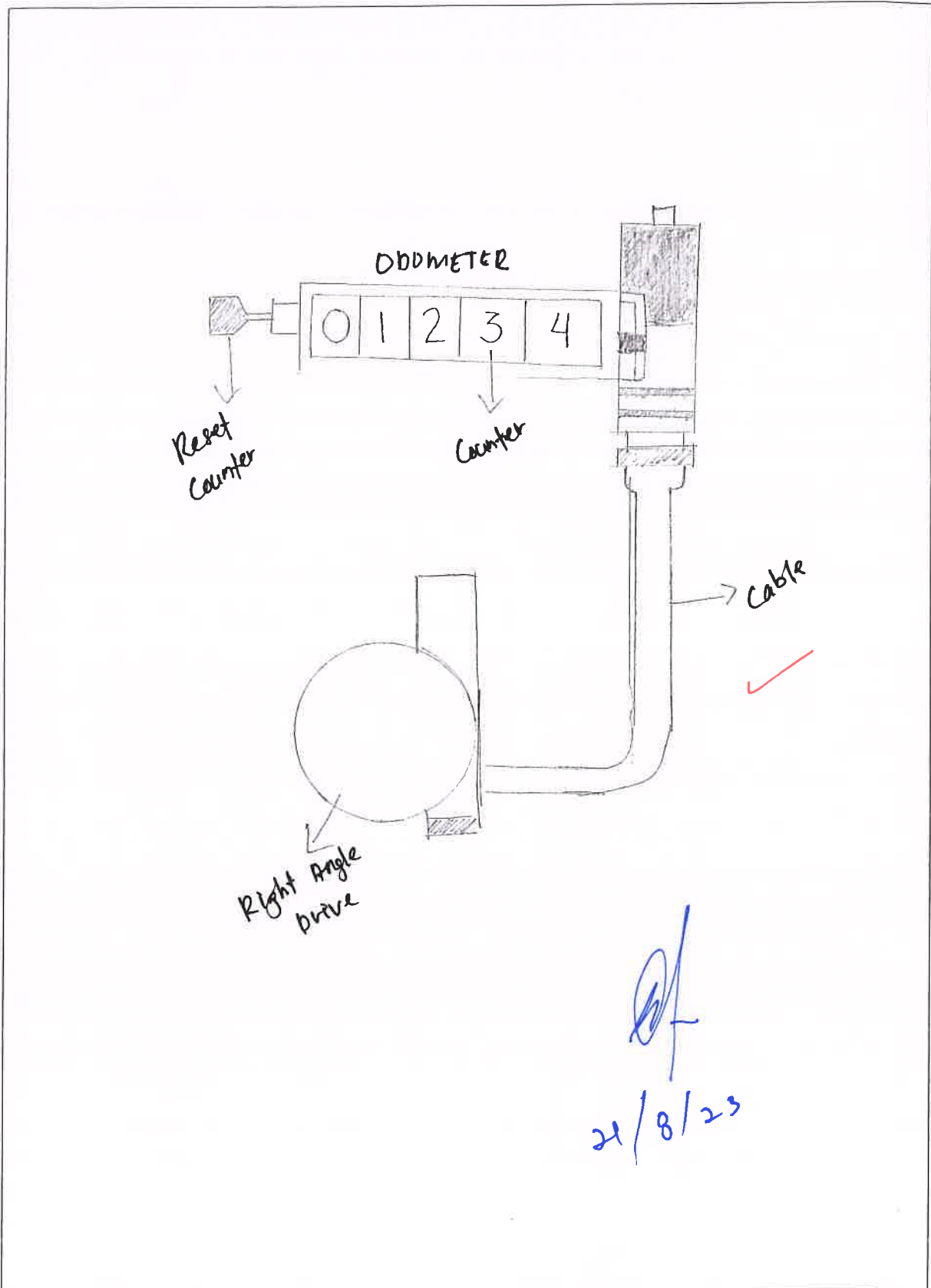



7. Weight indicator (200 lbs and 4000 lbs)

What is Weight Indicator

- ✓ - weight indicator systems are designed to provide accurate measurement of downhole tool weight during wireline operation.

What is the purpose of Weight Indicator

- ✓ - As a guide operator during running tool into the well.

How to operate Weight Indicator

- ✓ - connect weight indicator with load cell
- ✓ - load cell connect with log pulley

What is maintenance required for Weight Indicator

- ✓ - calibrate gauge
- ✓ - remove bubble in the hose
- ✓ - TOPUP OIL - WIS.

What is safety precaution required for Weight Indicator

- ✓ - must secure proper gauge
- ✓ - must secure hose properly

What is potential hazard during handling Weight Indicator

- ✓ - incorrect reading gauge
- ✓ - hose burst

  
21/8/23



Draw & name each part of Weight Indicator

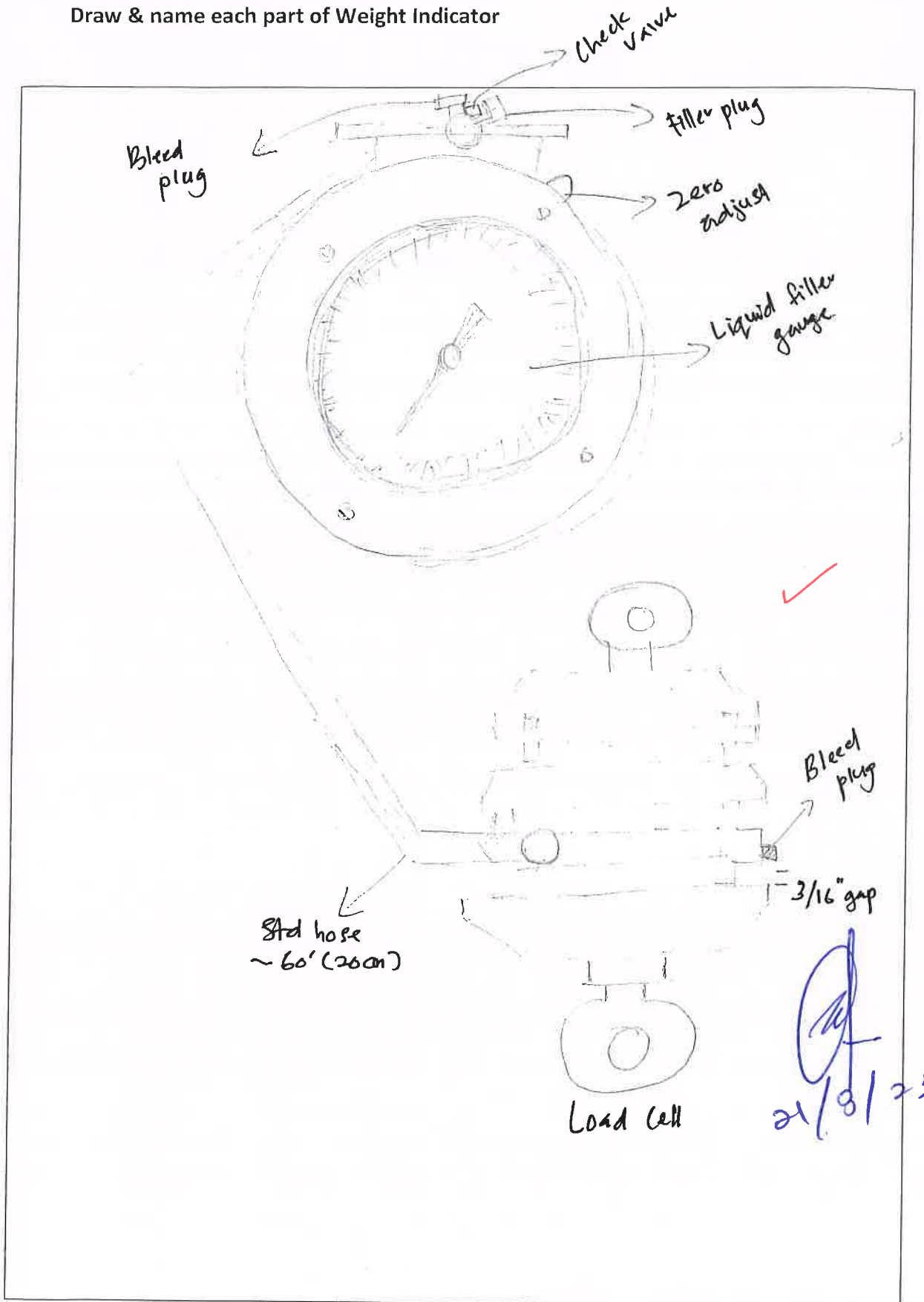



8. Spooling Device

What is Spooling Device

✓ Spooling device is device to spool new wire from reel to drum or drum wire to another drum

What is the purpose of Spooling Device

✓ purpose to tension wire while spool new wire into the drum

How to operate Spooling Device

✓ must connect powerpack hose to spooling device.

What is maintenance required for Spooling Device

✓ check hydraulic regulator  
✓ check gear oil

What is safety precaution required for Spooling Device

✓ - Barricade work site area  
✓ - Full PPE

What is potential hazard during handling Spooling Device

✓ - Hose burst  
✓ - High tension wire

  
21/8/23



**Draw & name each part of Spooling Device**

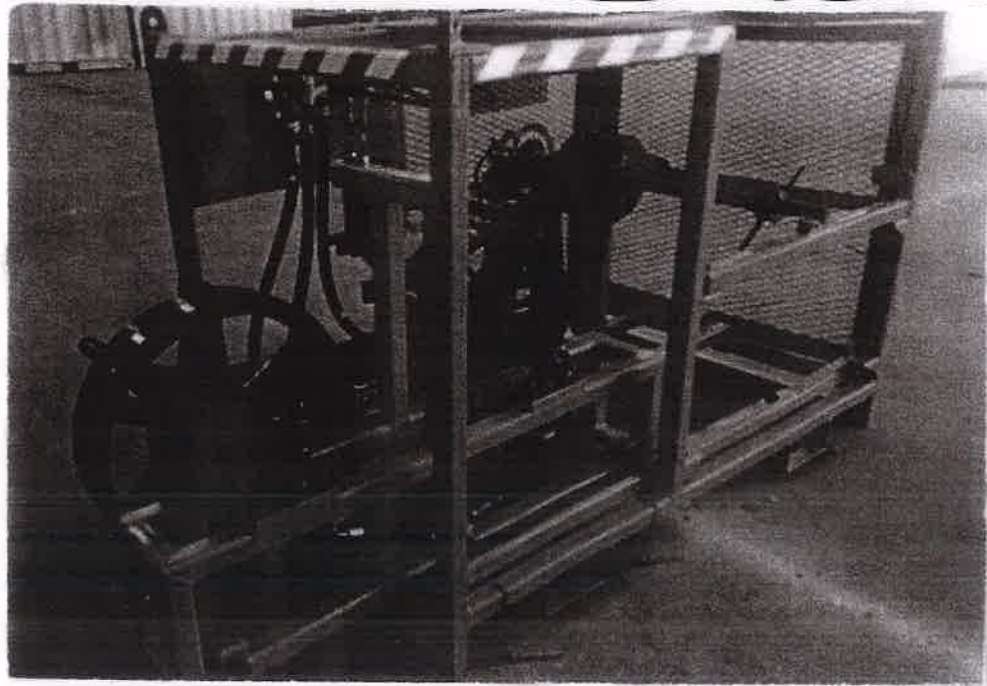

- ✓ Spooler drum
- ✓ Drive Sprocket
- ✓ Pre-set spooling
- ✓ Double brake in parallel

*Chavez* 2/1/08/20



9. Control Panel

What is Control Panel

Control panel is device that contain gauge, air regulator and hydraulic to supply pressure

What is the purpose of Control Panel

To operate surface equipment example to open and close Bop, stuffing Box, Hydraulic ball valve.

How to operate Control Panel

connect incoming air supply to control panel  
using regulator to pressure up line

What is maintenance required for Control Panel

check gauge  
check hoses  
check all tubing and connection  
check hydraulic air

What is safety precaution required for Control Panel

secure all hoses connection  
Don't stand at line of fire  
check all connection and fitting

What is potential hazard during handling Control Panel

Hoses burst  
Tubing leaking / parted  
High pressure

  
21/8/23



Draw & name each part of Control Panel

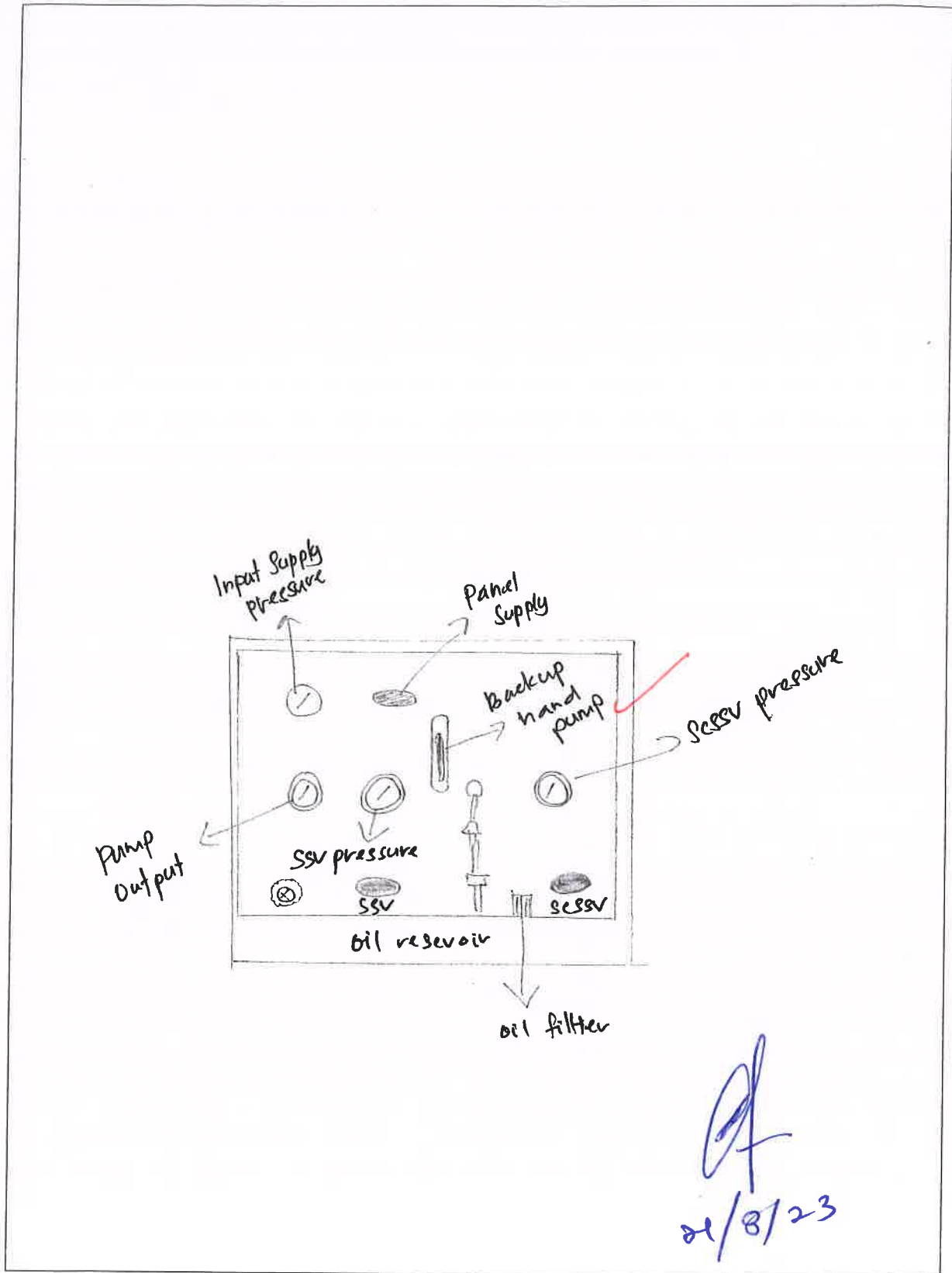



10. Huskel ~~Drum~~ <sup>pump</sup> .

What is Huskel ~~Drum~~

✓ - Huskel pump is to generate fluid pressure

What is the purpose of Huskel ~~Drum~~

✓ - to convert air pressure to hydraulic pressure / fluid pressure.

✓ - fill up water

How to operate Huskel ~~Drum~~

✓ - Air supply control by air regulator

What is maintenance required for Huskel ~~Drum~~

✓ - redress kit

✓ - service pump

What is safety precaution required for Huskel ~~Drum~~

✓ - Barricade area while function test

What is potential hazard during handling Huskel ~~Drum~~

✓ - Air hose burst

✓ - treat pressure

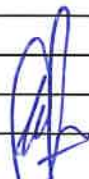
  
21/8/23



Draw & name each part of Huskel Drum

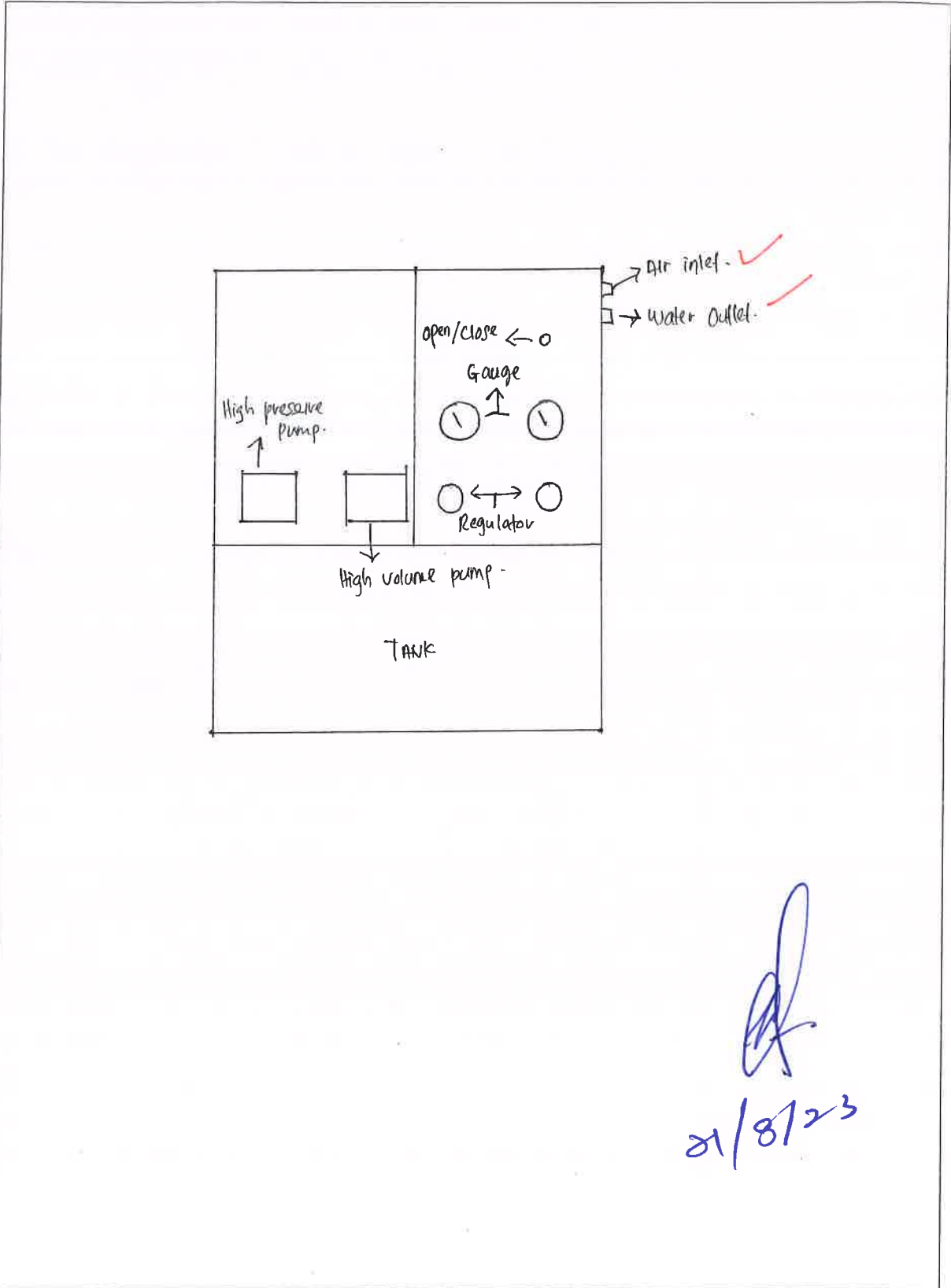



11. Power Pack (Electrical & Diesel)

What is Power Pack

✓ Power pack is hydraulic supplier that contains engine to run hydraulic pump

What is the purpose of Power Pack

✓ To supply hydraulic for run hydraulic motor  
- perform heavy-duty tasks.

How to operate Power Pack

✓ Connect hydraulic hose to RSU then connect air hose to power pack to start.

What is maintenance required for Power Pack

✓ change engine oil, filter and check drain water on tank  
✓ service when running hour

What is safety precaution required for Power Pack

✓ make sure hose in good condition  
✓ make sure check engine oil, water before start  
✓ make sure engine in good condition

What is potential hazard during handling Power Pack

✓ High pressure  
✓ Noise  
✓ rotating part  
✓ Hot engine

  
21/8/23



**Draw & name each part of Power Pack**

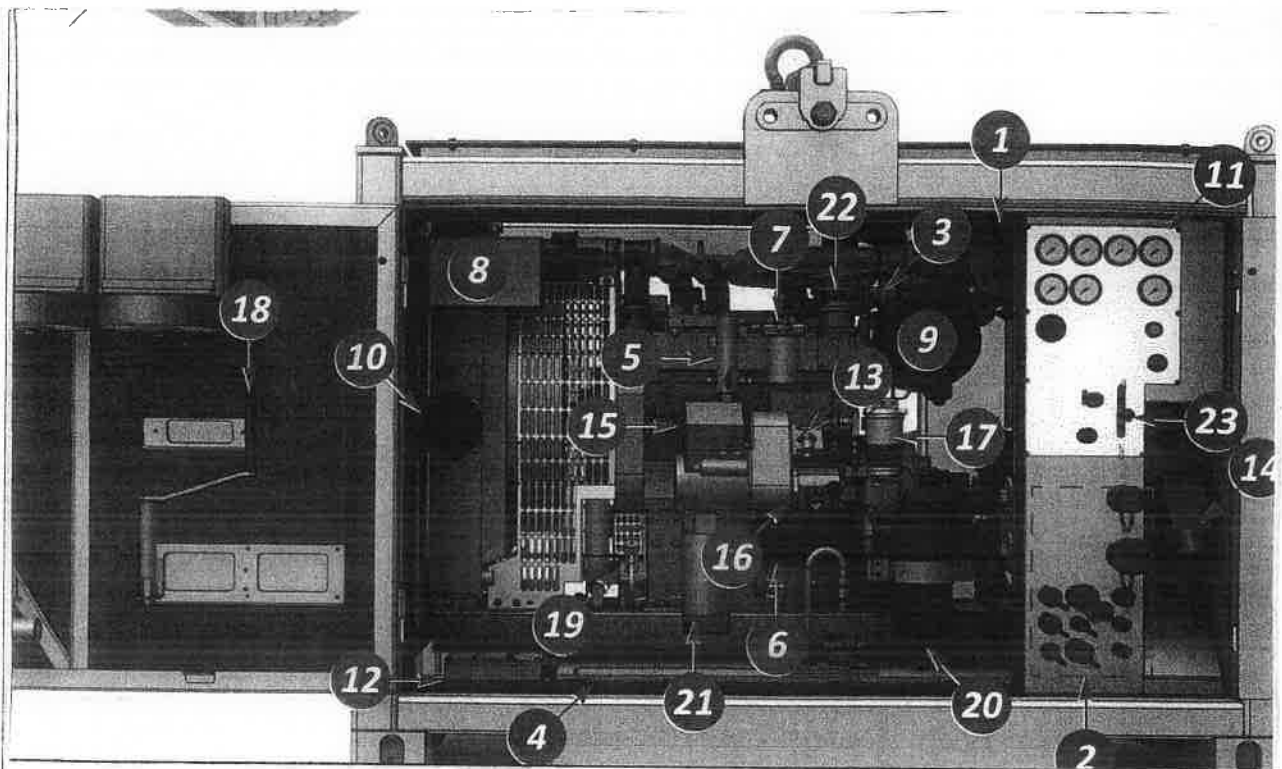

- |  |                                  |
|--|----------------------------------|
| ① Exhaust silencer   | ② Fuel Purifier                  |
| ② Pneumatic and hydraulic connectors                       | ③ Engine Oil Filter              |
| ③ Engine Flame Trap Breather (zone 2 only)                 | ④ Engine Air Intake Safety Valve |
| ④ Fuel Tank  | ⑤ Air Inlet Valve Control Handle |
| ⑤ Fuel Safety (sentinel) valve                             |                                  |
| ⑥ Spring starter   |                                  |
| ⑦ Fuel Fine Filter   |                                  |
| ⑧ Electric Junction Box                                    |                                  |
| ⑨ Engine Air Intake Filter (Naturally aspirated powerpack) |                                  |
| ⑩ Battery Isolation Switch                                 |                                  |
| ⑪ Control Panel  |                                  |
| ⑫ Fuel Pre filter & water separator                        |                                  |
| ⑬ Spring starter Crank Handle                              |                                  |
| ⑭ Engine Oil Sump Pump                                     |                                  |

*James 20/06/23*



12. Air Compressor

What is Air Compressor

✓ Air compressor is surface equipment that use to storage air. to supply to test pump and control panel.

What is the purpose of Air Compressor

✓ To supply air for the use to start surface equipment use air starter system.

How to operate Air Compressor

✓ - using spring starter, hydraulic starter to power up  
✓ - setting air pressure using PRV

What is maintenance required for Air Compressor

✓ - change engine oil, filter, air cooler and water  
✓ - check hose in good condition

What is safety precaution required for Air Compressor

✓ - make sure engine in good condition  
✓ - Beware with rotating part

What is potential hazard during handling Air Compressor

✓ - Noise  
✓ - High pressure air  
✓ - Hose burst

  
21/8/23



**Draw & name each part of Air Compressor**

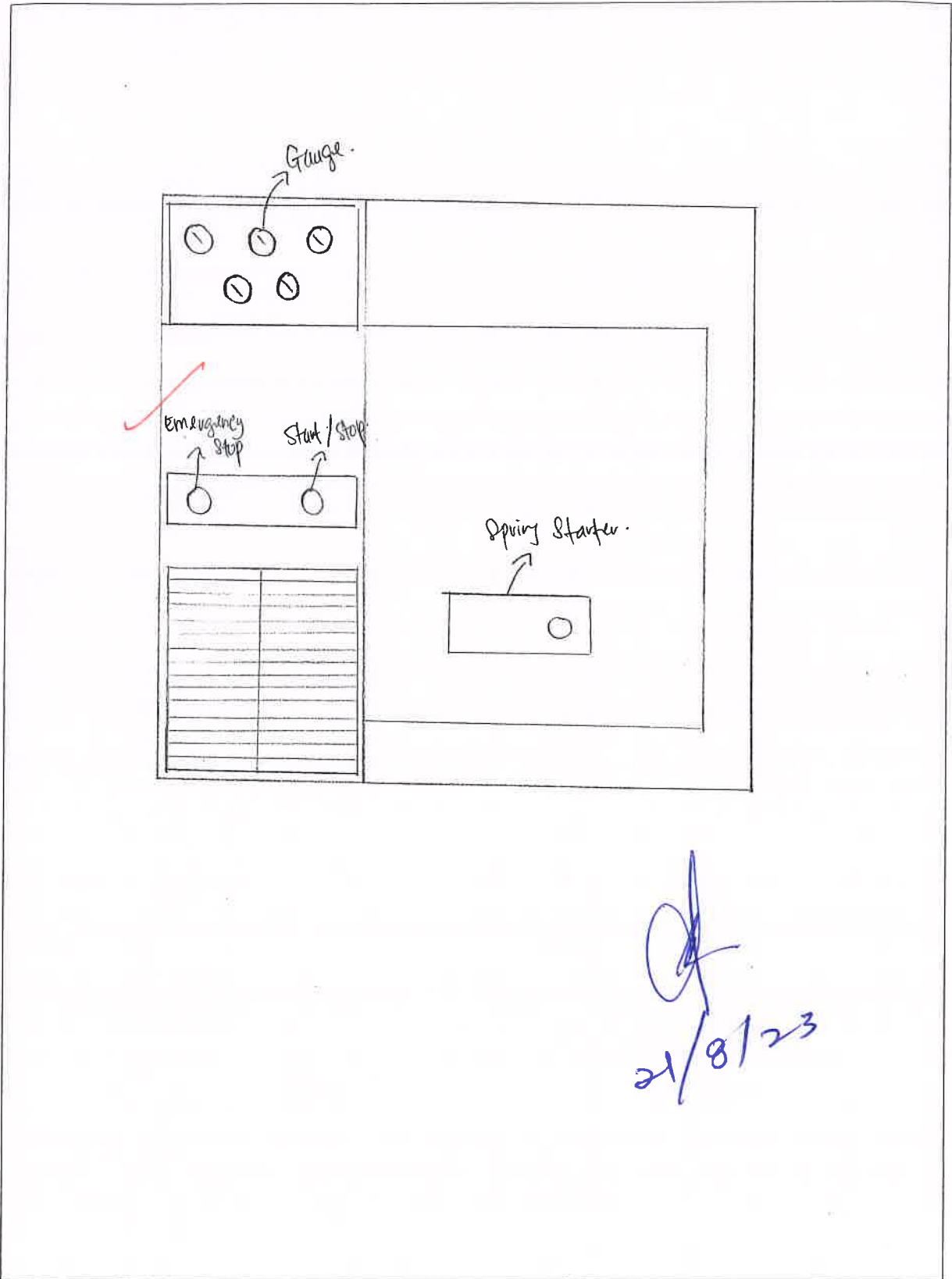

*[Signature]*  
21/8/23



13. Drum

What is the purpose of Drum

- to inside the wire
- keep storage the wire

Do the right and wrong wire arrangement from drum to hav pulley

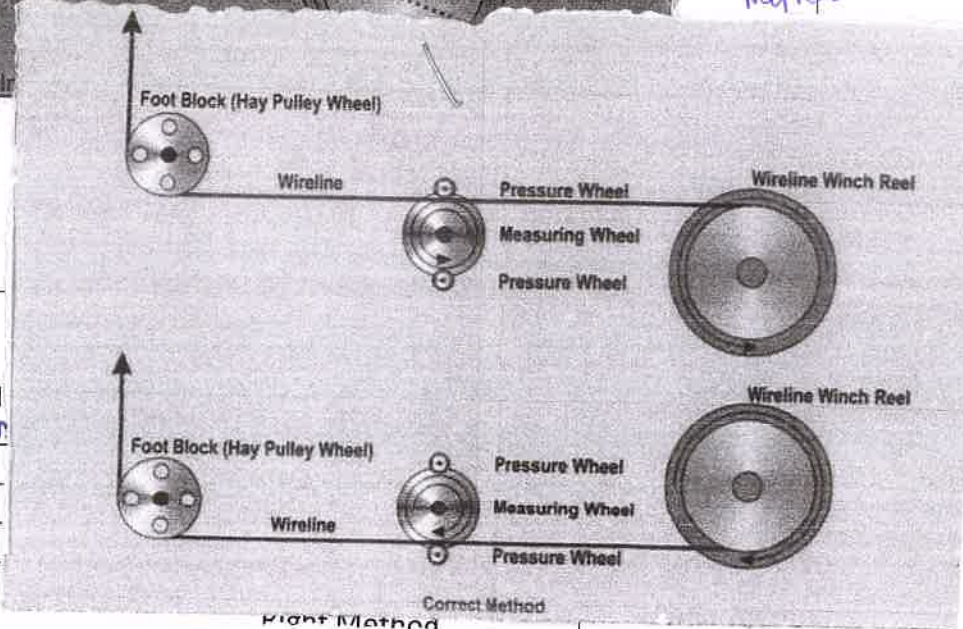
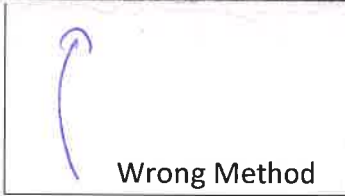
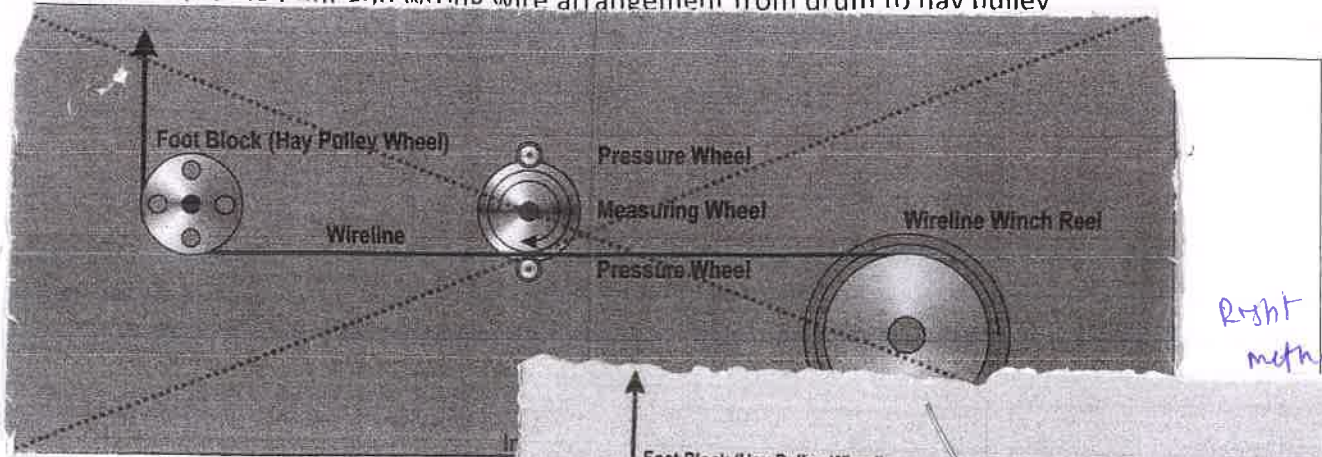

What is maintenance req

- Greasing bearing

What is safety precaution required for Drum

- make sure wire direction is correct way

What is potential hazard during handling Drum

- pitch point
- sharp edge

*[Handwritten signature]*  
21/8/23



Please draw/sketch the toolstring configuration for:

- 1) Drift run/tubing clearance check
- 2) Sinker bar run
- 3) Set and retrieve plug
- 4) Set and retrieve insert valve

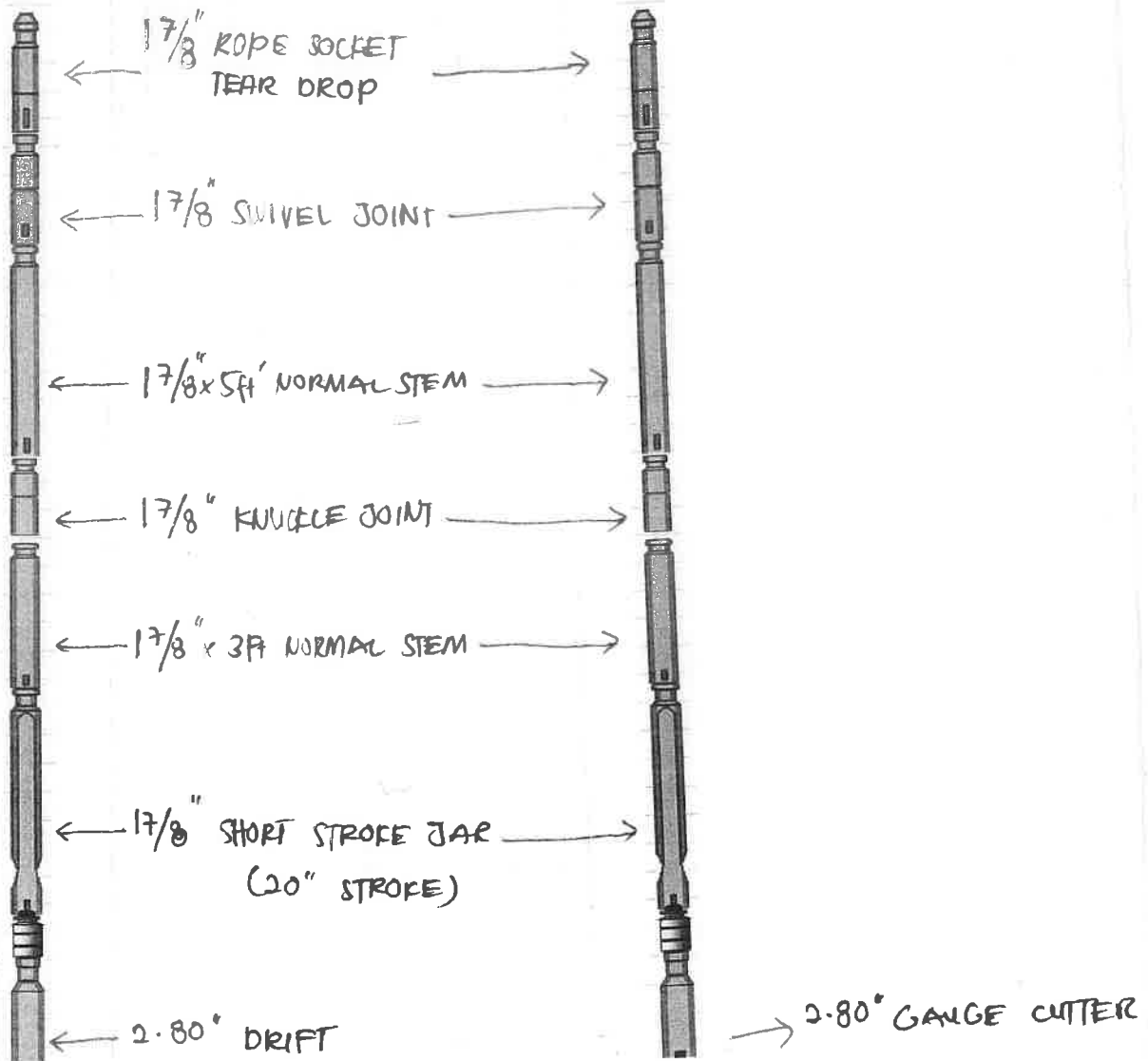

*James* 21/08/23

2) SINKER BAR

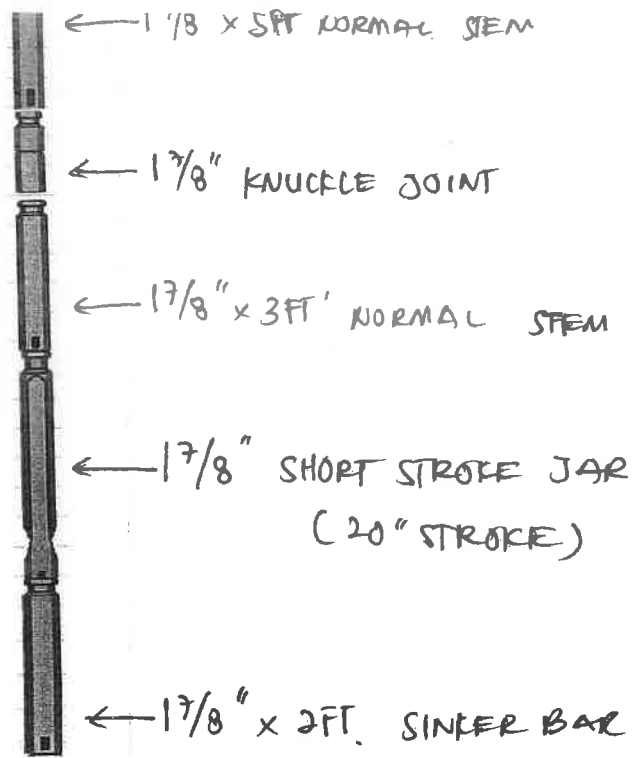

James 21/08/23

8) SET AND RETRIEVE PLUG

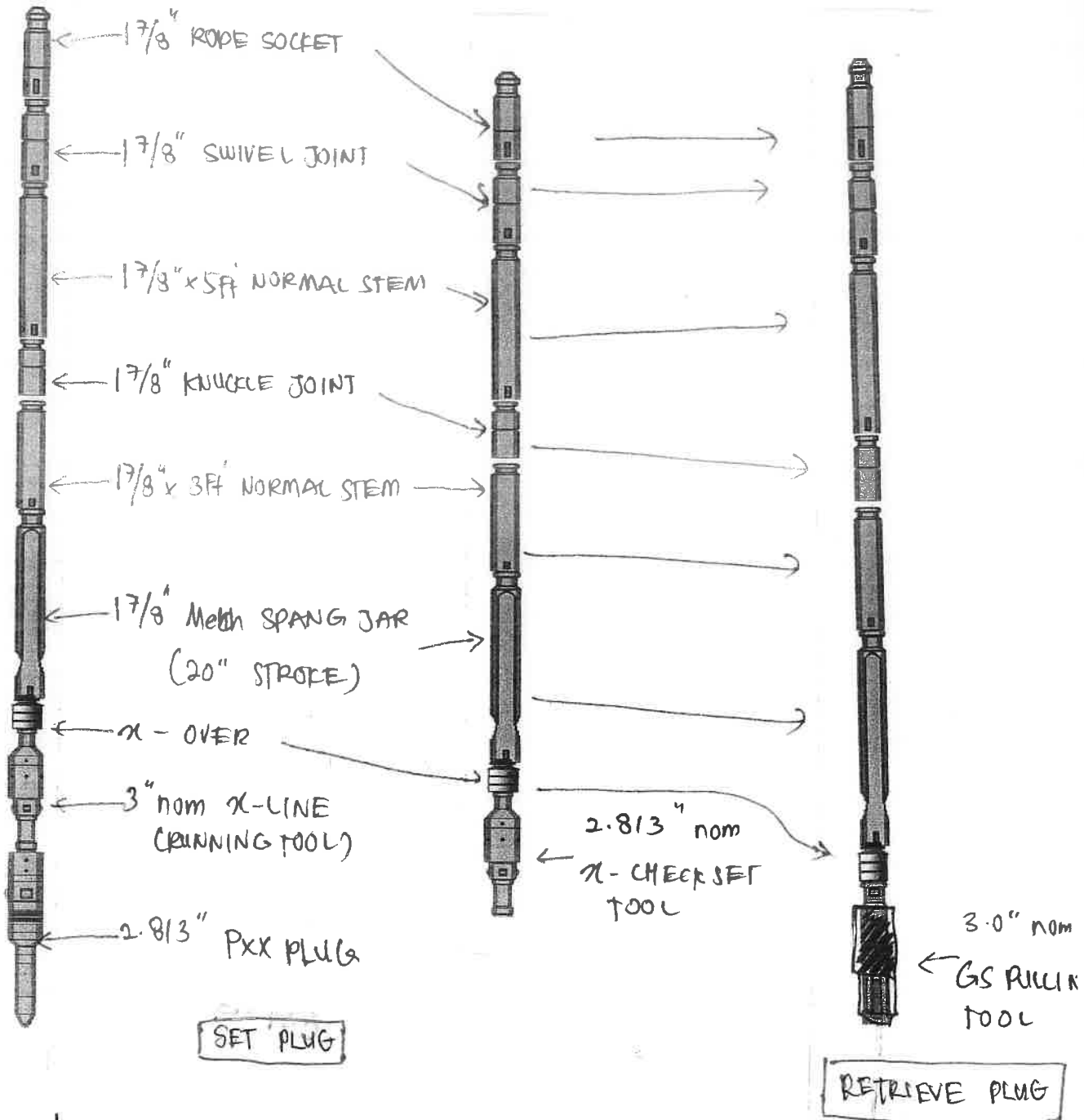

James 21/08/23

✓ 4) SET AND RETRIEVE INSERT VALVE

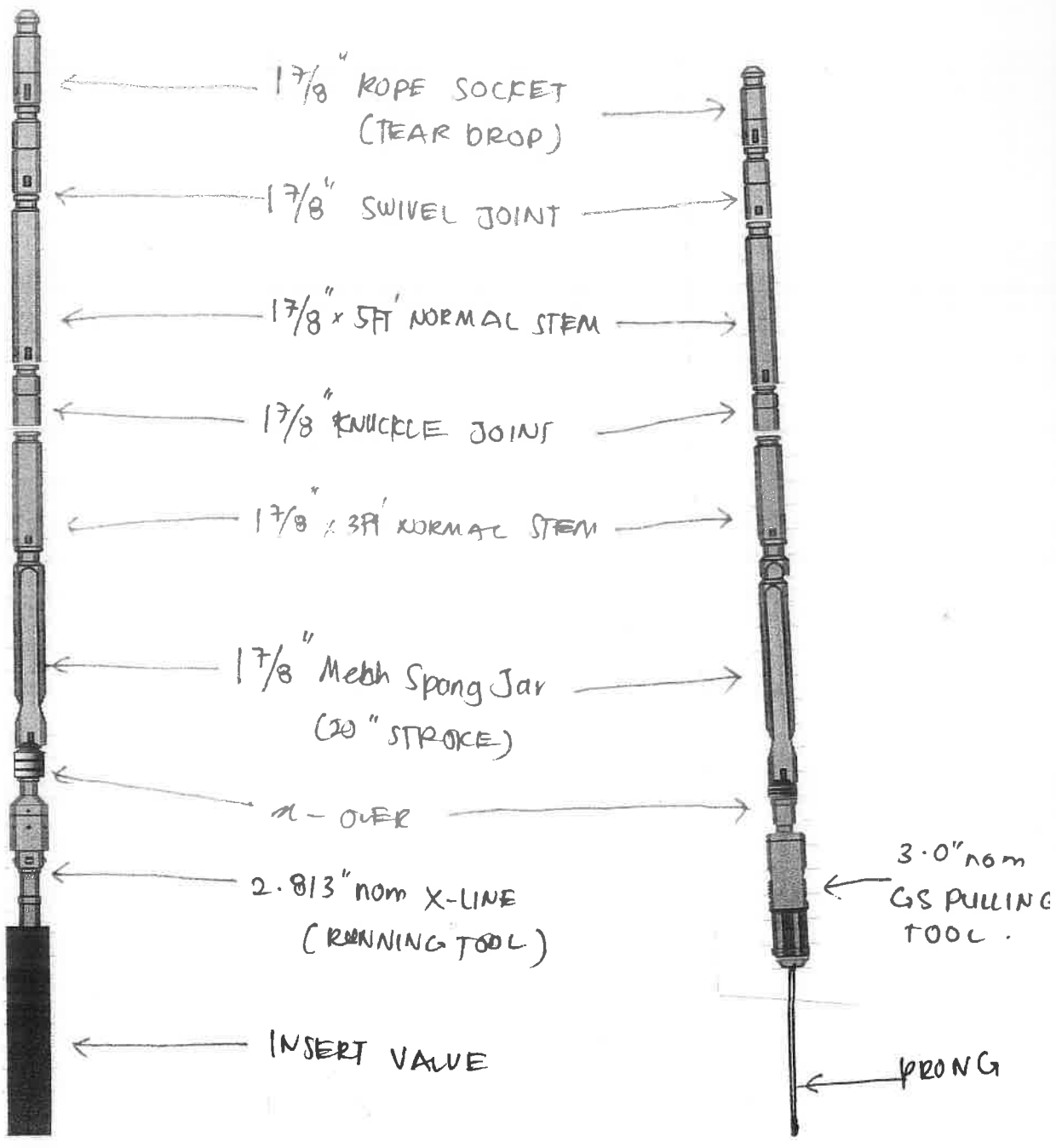

SET INSERT VALVE

RETRIEVE INSERT VALVE

James 21/08/23