

DIMENSION BID

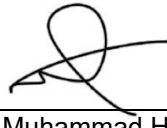

DULANG C-4 S CEMENT PACKER

Revision: 3
Prepared for: Hanisah
Date Prepared: 7th November 2023
Well: C-4 S
Field: DULANG
Operation Region: PMA
Prepared by: Muhammad Hafiz
Phone: +6019-2640410
Email: Hafiz.saharuddin@neudimension.com

DESIGN VERIFICATION**PREPARED BY DB**
CTS Operation Engineer

Muhammad Hafiz

20/3/2024
Date**REVIEWED BY DB**
CTS Technical Advisor

Kung Yee Han

20/3/2024
Date**APPROVED BY DB**
CTS General Manager

Aliff Adenan

20/3/2024
Date**APPROVED BY PCSB**
Dulang
Well Intervention Engineer

Hanisah

Date

APPROVED BY PCSB
Technical Professional
Well Intervention, PMA

Izwan Jalil

Date

APPROVED BY PCSB
Head of Cluster 2
Well Intervention, PMA

Hafizi Zaini

Date

Remark: Do not execute the procedures in this document if it is not fully approved and signed by all parties.

DISTRIBUTION LIST

No	Personnel	Company	Name	Email
1	Well Intervention Engineer	PCSB	Hanisah / Zhafran	nurhanisah.ahmad@petronas.com Zhafran.rahman@petronas.com
2	Well Service Supervisor (WSS)	PCSB	TBA	TBA
3	Offshore Installation Manager (OIM)	PCSB	TBA	TBA
4	Tech Professional	PCSB	Izwan Jalil	izwanjalil@petronas.com
5	Cluster Head	PCSB	Hafizi Zaini	Hafizi.zaini@petronas.com
6	Head of well Intervention	PCSB	Eddy Samaile	Eddysamaile@petronas.com
7	Material Coordinator (Logistics)	DB – Kemaman	Marzokey	marzokey@neudimension.com
8	Service Supervisor	DB – Kemaman	TBA	TBA
9	Operation Engineer CT Services	DB – Kemaman	Muhammad Hafiz	hafiz.saharuddin@neudimension.com
10	Operation Engineer CT Services	DB – Kemaman	Mohammad Faizal Ali	faizal.ali@neudimension.com
11	Technical Advisor CT Services	DB – Kemaman	Kung Yee Han	yeehan.kung@neudimension.com
12	Field Service Manager CT Services	DB – Kemaman	Mohd Khairul Ridhwan	khairul.ridhwan@neudimension.com
13	General Manager CT Services	DB – Kemaman	Aliff Amirul Adenan	aliff.adenan@neudimension.com
14	HSE Supervisor	DB – Kemaman	Ahmad	ahmad@neudimension.com

DIMENSION BID	DIMENSION BID COILED TUBING SERVICES		
	DULANG C-4 S	CEMENT PACKER	

PERSONNEL CONTACT

Any means of following doubt / unusual parameters / Emergency, please contact Dimension Bid personnel in onshore immediately.

No	Name	Position	Company	Location	Contact No
1	Muhammad Hafiz	Operation Engineer	DB	Kemaman	019 – 264 0410
2	Mohammad Faizal Ali	Operation Engineer	DB	Kemaman	013 – 736 1046
3	Kung Yee Han	Technical Advisor	DB	Kemaman	019 – 610 2088
4	Mohd Khairul Ridhwan	Field Services Manager	DB	Kemaman	014 – 515 4452
5	Alif Adenan	General Manager	DB	Kemaman	011 – 1225 7044

REVISION HISTORY

Rev. No	Section	Date	Revised By
0	All	7/11/2023	Muhammad Hafiz
1	Revised overall procedure which include new cement volume	12/3/2024	Muhammad Hafiz
2	Change TFW to TSW	17/3/2024	Muhammad Hafiz
3	Revise Additional step during cementing	20/3/2024	Muhammad Hafiz

ACRONYM

Acronym	Abbreviation
BHA	Bottom Hole Assembly
RIH	Run In Hole
POOH	Pull Out of Hole
HUD	Hang Up Depth
TCC	Tubing Clearance Check
SCO	Sand Clean Out
TIT	Tubing Integrity Test

BOP	Blow Out Preventer
CT	Coiled Tubing
ID	Internal Diameter
MDTHF	Measure Depth Tubing Head Flange
TOP	Top of Plug
MASTP	Maximum Allowable Surface Treating Pressure
STP	Surface Treating Pressure

Prepared By: Muhammad hafiz	Reviewed By: Kung Yee Han	Date: 20/3/2024	Rev. Rev3	Controlled Document DB-CT-MHS-230238	Pg. 4
--------------------------------	------------------------------	--------------------	--------------	---	----------

TABLE OF CONTENT

DESIGN VERIFICATION	2
DISTRIBUTION LIST	3
PERSONNEL CONTACT	4
REVISION HISTORY	4
ACRONYM	4
TABLE OF CONTENT	5
OBJECTIVES	7
BACKGROUND	7
WELL DATA	8
OPERATION SUMMARY	9
WELL DIAGRAM	10
WELL 3D PLOT	12
TREATMENT VOLUME.....	13
CT STRING INFORMATION	14
CT STRING FATIGUE.....	14
SAFETY OPERATIONAL PROCEDURES.....	16
HEALTH, SAFETY & ENVIRONMENT	17
EQUIPMENT RIG UP PROCEDURE.....	18
EQUIPMENT PRESSURE TESTING PROCEDURE.....	20
OPERATIONAL PROCEDURE	21
CT RUN#3: DEPTH CORRELATION / DRIFT RUN.....	21
CT RUN#4: CEMENTING OPERATION.....	24
CT RUN#5: CLEANOUT UNTIL TOP OF CEMENT RETAINER (2,170 m / 7,119 ft MDTHF)	31
CT RUN#6: CT UNLOADING.....	36
APPENDIX I – BHA SCHEMATIC	38
BHA#1: 1-11/16 SpinCAT Nozzle	38
BHA#2: Depth Corelation / Drift Run	39
BHA#3: Cementing	40
BHA#4: 1-11/16 SpinCAT Nozzle	41
BHA#5: Unloading Tool.....	42
APPENDIX II – CT STACK UP.....	43
APPENDIX III – ORPHEUS SIMULATIONS	44
TUBING FORCE ANALYSIS UNTIL SSD#2 AREA.....	44
RIH & POOH WEIGHT	44
MAXIMUM STRING PICK UP LIMIT	45

DIMENSION BID	DIMENSION BID COILED TUBING SERVICES		
	DULANG C-4 S	CEMENT PACKER	

STRING LIMIT	46
PICK-UP FORCE AT CR SETTING DEPTH	46
SENSITIVY ANALYSIS TFA	47
SENSITIVY ANALYSIS TFA	49
APPENDIX IV – EMERGENCY PROCEDURE	52
EMERGENCY BOP OPERATIONS.....	52
LEAK IN CT AT SURFACE.....	53
LEAK IN CT BELOW SURFACE	53
LEAK IN SURFACE PRESSURE CONTROL EQUIPMENT.....	54
CT RUNS AWAY INTO WELL	55
CT IS PULLED OUT OF STUFFING BOX.....	56
CT COLLAPSED AT SURFACE.....	56
CT BREAKS AT SURFACE.....	56
BUCKLED TUBING	57
CT STUCK IN HOLE PROCEDURES.....	58
STUCK CT COIL RECOVERY PROCESS.....	60
APPENDIX V – DOWNHOLE TOOL SPECS	61
APPENDIX VI – CIRCA SIMULATION	63
APPENDIX VII – CERBERUS CEMENT PUMPING SIMULATION	83
APPENDIX VIII – CEMENT LAB REPORT	86

DIMENSION BID	DIMENSION BID COILED TUBING SERVICES		
	DULANG C-4 S	CEMENT PACKER	

OBJECTIVES

1. To perform Cement Packer prior for add perforation (convey via wireline) at 2,127m – 2,136m MDTHF

BACKGROUND

Dulang C-04 is dual string oil producer with selective type 5, completed completion on 1994. based on latest well intervention, experienced HUD at 1,985m MDTHF (Fe₂O₃ scale).

After the cleanout operation, Archer completed the WLD (Well Logging and Data) and observed a leak at the intended cement placement. Discussions were held, and it was decided to reduce the propose TOC inside the A-Annulus.

Prepared By: Muhammad hafiz	Reviewed By: Kung Yee Han	Date: 20/3/2024	Rev. Rev3	Controlled Document DB-CT-MHS-230238	Pg. 7
--------------------------------	------------------------------	--------------------	--------------	---	----------

DIMENSION BID	DIMENSION BID COILED TUBING SERVICES		
	DULANG C-4 S	CEMENT PACKER	

WELL DATA

Input Parameter	Parameter Value
Field	Dulang Charlie
Max. Deviation (degrees)	62.5" at 789 m
Min. Restriction (inch)	2.25" @ No Go nipple
Type of Fluid & Density	Oil
Top of Fluid	TBC
Current Well Status	Shut-in
Reservoir Pressure	950 psi
Reservoir Temperature	212 deg F
Fracture Gradient	0.6 – 0.7 psi/ft
H2S Content	N/A
CO2 Content	60%
Mercury, HG	N/A

Prepared By: Muhammad hafiz	Reviewed By: Kung Yee Han	Date: 20/3/2024	Rev. Rev3	Controlled Document DB-CT-MHS-230238	Pg. 8
--------------------------------	------------------------------	--------------------	--------------	---	----------

DIMENSION BID	DIMENSION BID COILED TUBING SERVICES		
	DULANG C-4 S	CEMENT PACKER	

OPERATION SUMMARY

Item	Job Description	Remark
A	Slickline	<ol style="list-style-type: none"> 1. Set Widepack plug at depth 2,180m 2. Open SSD#1 (2,174m/7,133ft MDTHF) 3. Tubing Punch SSD#1 (2,174m/7,133ft MDTHF)
B	Bullheading Pumping	<ol style="list-style-type: none"> 1. Injectivity Test after tubing punch 2. Casing Pickling
C	Slickline	<ol style="list-style-type: none"> 1. Set Modified cement retainer (2,173m/7,129 ft MDTHF)
D	CT Operation (Part 2)	<ol style="list-style-type: none"> 1. Depth Correlation /Drift Run prior for CT Packer. 2. Set CT Packer Cement retainer and perform cementing 3. Post cementing cleanout 4. Nitrogen Unloading until depth 2,000m/6562ft MDTHF

DIMENSION BID	DIMENSION BID COILED TUBING SERVICES		
	DULANG C-4 S	CEMENT PACKER	

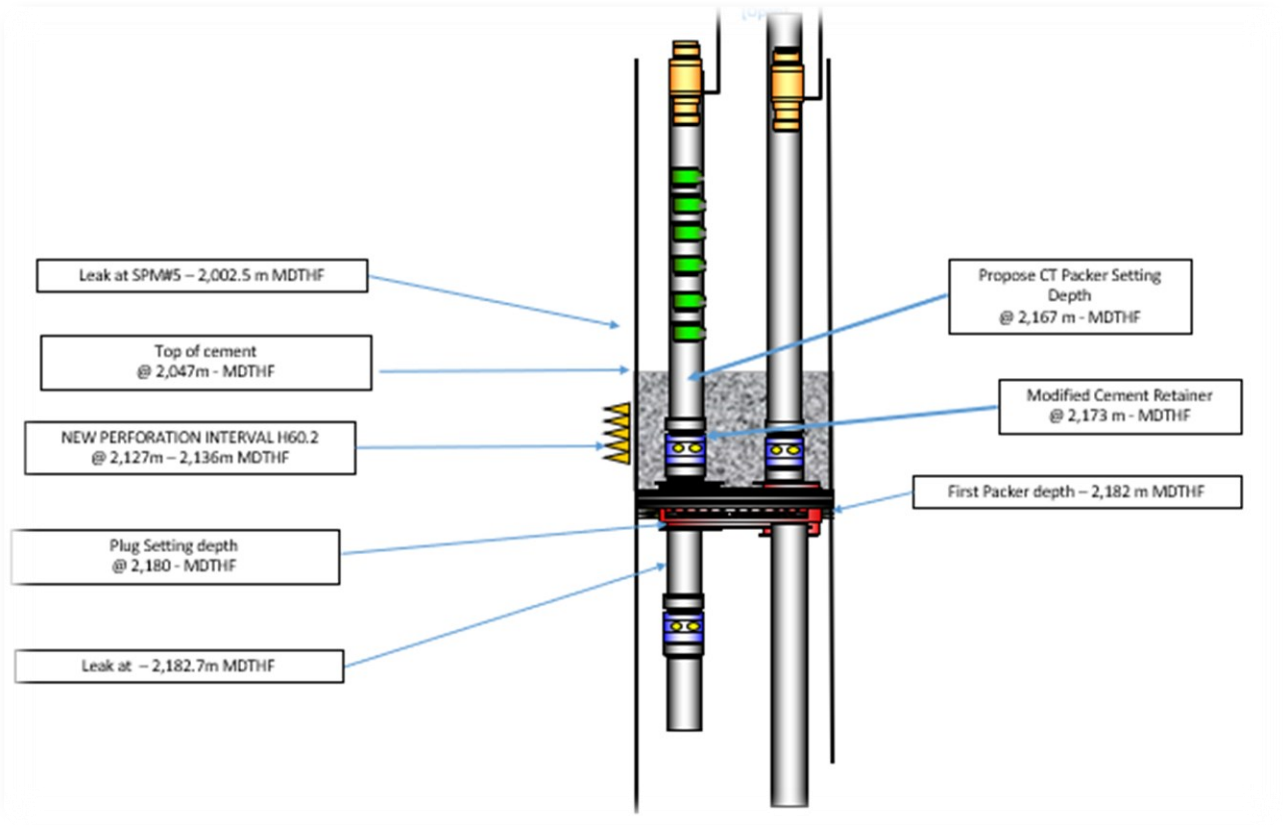

DIMENSION BID	DIMENSION BID COILED TUBING SERVICES		
	DULANG C-4 S	CEMENT PACKER	

WELL 3D PLOT

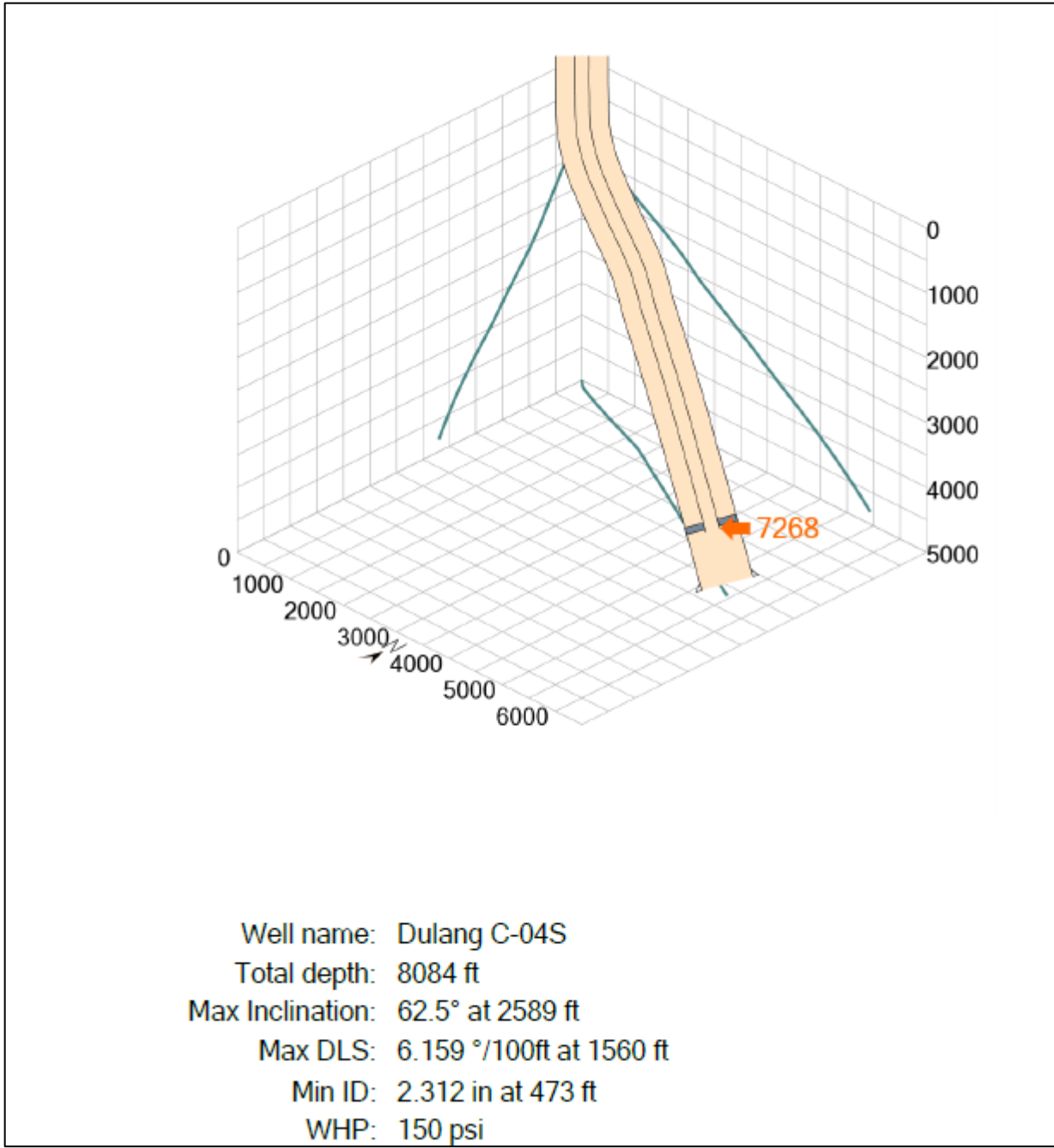

Prepared By: Muhammad hafiz	Reviewed By: Kung Yee Han	Date: 20/3/2024	Rev. Rev3	Controlled Document DB-CT-MHS-230238	Pg. 12
--------------------------------	------------------------------	--------------------	--------------	---	-----------

TREATMENT VOLUME

Description	Details
Tubing Specification	2-7/8" 6.5 ppf
Production Casing Specification	9-5/8" 40 ppf# N80

Type	Volume														Total Volume (bbls)	
	External Pipe			Internal Pipe 1			Internal Pipe 2			Caps	From	To	From	To		Length
	OD (inch)	ID (inch)	W(lb/ft)	OD (inch)	ID (inch)	W(lb/ft)	OD (inch)	ID (inch)	W(lb/ft)	Barrel/lin (ft)	m	m	ft	ft		ft
Tubing volume until EOT	2 7/8	2.441								0.00579	0	1,800	0	5,906	5,906	34.18
PCP volume	9 5/8	8.835		2 7/8			2 7/8			0.05977	0	2,182	0	7,158	7,158	427.82
Original Cement Volume - 150m above top of perf																
Tubing volume SSD#1 to SSD#2	2 7/8	2.441								0.00579	2,170	2,180	7,120	7,153	33	0.19
Annular Volume from First packer to Top of cement (1,950 m)	9 5/8	8.835		2 7/8			2 7/8			0.05977	1,950	2,182	6,398	7,158	760	45.43
															TOTAL	45.62
Cement Volume until leak point																
Tubing volume plug below first packer to CR Setting depth	2 7/8	2.441								0.00579	2,170	2,180	7,120	7,153	33	0.19
Annular Volume from First packer to leak point	9 5/8	8.835		2 7/8			2 7/8			0.05977	2,003	2,182	6,572	7,158	586	35.04
															TOTAL	35.23
Cement Volume 45m below Leak Area																
Tubing volume from plug below first packer to CR Setting depth	2 7/8	2.441								0.00579	2,173	2,180	7,130	7,153	23	0.13
Annular Volume from First packer to Top of cement	9 5/8	8.835		2 7/8			2 7/8			0.05977	2,047	2,182	6,716	7,158	442	26.41
															TOTAL	26.55
Cement Volume between CT packer and Cement Retainer																
Tubing volume CT packer and Cement retainer	2 7/8	2.441								0.00579	2,163	2,173	7,097	7,130	33	0.19
Contaminated Gel Volume from Cement retainer to Leak area	2 7/8	2.441								0.00579	2,003	2,173	6,570	7,130	559	3.24
Annular Volume from First packer to leak area	9 5/8	8.835		2 7/8			2 7/8			0.05977	2,003	2,182	6,570	7,158	588	35.14

80 m above top of perforation

DIMENSION BID	DIMENSION BID COILED TUBING SERVICES		
	DULANG C-4 S	CEMENT PACKER	

CT STRING INFORMATION

OD (in)	Spec	W/T (in)	ID (in)	Length (ft)
1.5	TS-80	0.118	1.264	12,100
CT Volume: 18.8 bbls				

CT STRING FATIGUE

- Current **used life** for Jason #633207 is at **45.29%**

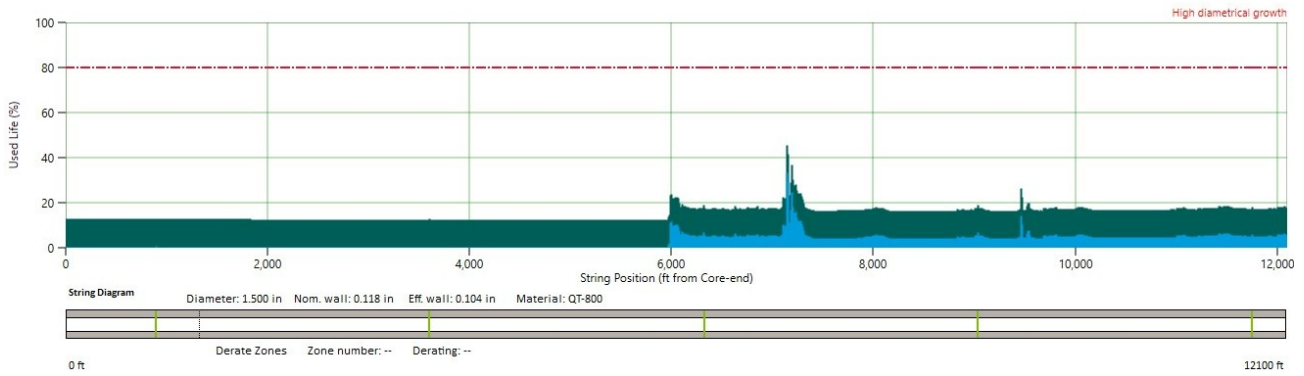

Prepared By: Muhammad hafiz	Reviewed By: Kung Yee Han	Date: 20/3/2024	Rev. Rev3	Controlled Document DB-CT-MHS-230238	Pg. 14
--------------------------------	------------------------------	--------------------	--------------	---	-----------

PROCESS FLOW DIAGRAM

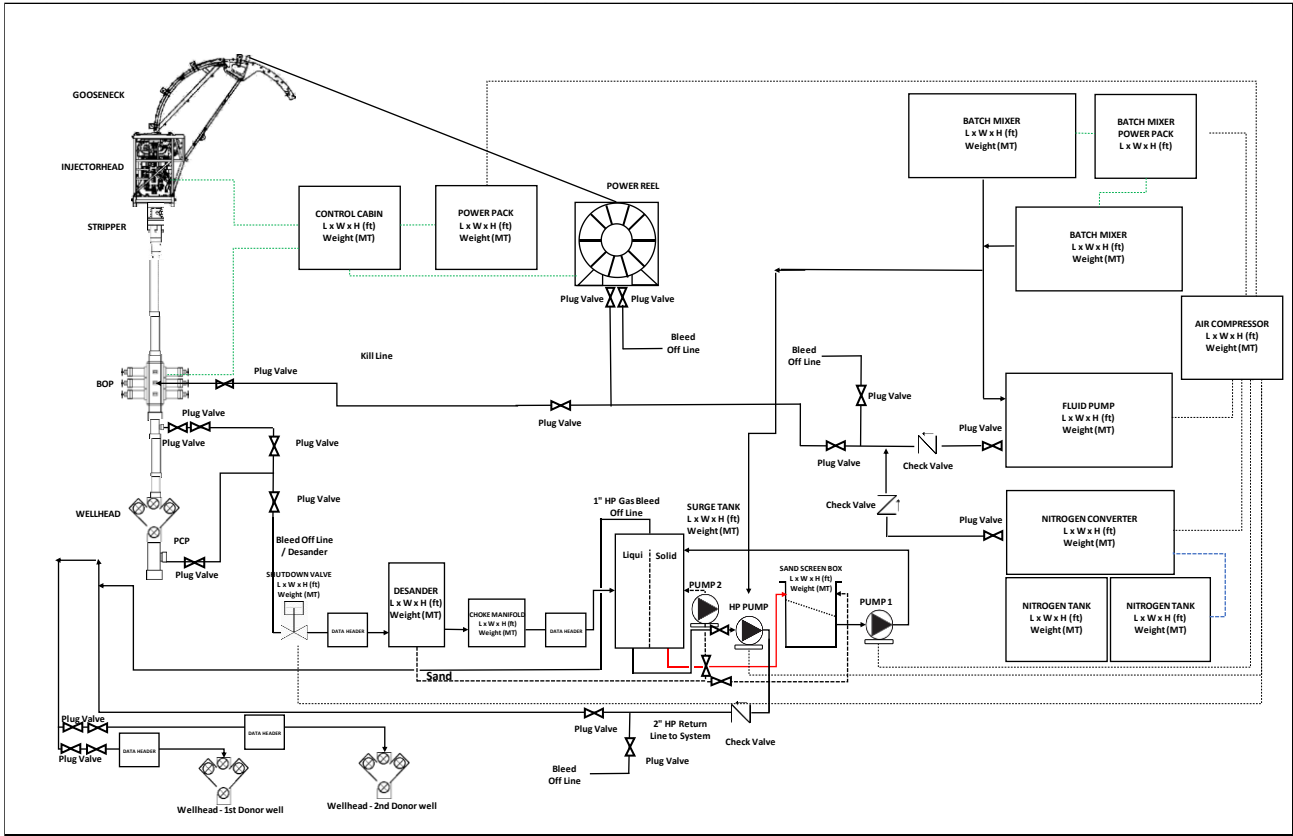

CLIENT	PETRONAS CARIGALI SDN. BHD.
WELL NAME	
JOB DESCRIPTION	
REVISION	0

DIMENSION BID	DIMENSION BID COILED TUBING SERVICES		
	DULANG C-4 S	CEMENT PACKER	

SAFETY OPERATIONAL PROCEDURES

Prior to commencement of the CT / Bullheading operation, a pre-job meeting will be held. This should be attended by the following parties as a minimum:

OIM, WSS, CT Supervisor, Representatives of other service companies involved and others as necessary.

Safety meetings should be held at the start of every shift and risk assessments must be evaluated during this time. Tool box talks should be held immediately prior to the job execution.

Note: The safety meeting must be driven by DB Supervisor addressing the following topics as a minimum:

1. Muster point.
2. Take list of personnel on site (Head count)
3. All personnel should review and be familiar with escape routes and emergency procedures.
4. Describe the **job objective, fluids and volumes to be pumped, pressures expected** during the job, and others.
5. Review **Dimension Bid Operations Policy and Procedure Manual**.
 - 5.1. Ensure at all steps carried out during the operations comply with this Manual.
 - 5.2. Management of change **MUST** be applied any time there is a need to deviate from the steps contained this procedure.
 - 5.3. A document **MUST** be created describing each the step of the deviation. This document shall also include the deviation Risk Assessment and it **MUST** be approved and signed by PCSB – Head of Well Intervention and Dimension Bid Operations Manager.
6. Exercise Stop work authority if unsafe condition occurs and assess situation with all team members, resume operation after mitigation plan is in place.
7. Personnel responsibilities throughout the job.
8. Spills, fire, blow out, unexpected well behaviour.
9. Emergency shower station and eye wash station location.
10. Trapped potential energy such as pressure or CT stiffness.
11. Prepare related Job Hazard Analysis (JHA) prior commencement of any work, get approval from Client Site Representative (CSR) and review it with all personnel involved as well as to review Risk Assessment.
12. Discuss the well H₂S, CO₂, Hg (Mercury) content (if applicable).
13. Adhere all **PCSB Zeto Rules** and other guidelines.
14. Take a physical count of inventory and make sure all required materials are available on site.
15. **Barricade** the work area and display the appropriate **warning sign**.
16. On chemical mixing and handling; all personnel involved shall hold **safety meeting** and review **Safety Data Sheet** (SDS).
 - 16.1. Personnel involve during chemical handling shall be briefed by DB Chemical Specialist onsite and extra precautions must be taken. All SDS must be available on site and reviewed prior chemical handling.
 - 16.2. All non-essential personnel shall stay away from mixing site.
 - 16.3. Use PPE including respirators, hard hats, eye protection and steel-toed boots.
 - 16.4. Verify if there is any **dead volume** in the mixing tanks and adjust volumes to account for non-usable volume in the blender / mix tank.
 - 16.5. Consider wind direction and note all trip hazards in the mix / pumping area.

Prepared By: Muhammad hafiz	Reviewed By: Kung Yee Han	Date: 20/3/2024	Rev. Rev3	Controlled Document DB-CT-MHS-230238	Pg. 16
--------------------------------	------------------------------	--------------------	--------------	---	-----------

DIMENSION BID	DIMENSION BID COILED TUBING SERVICES		
	DULANG C-4 S	CEMENT PACKER	

- 16.6. Prior to mixing chemicals, clean and verify the tank/batch mixer and lines are free of any debris and or contaminants.
- 16.7. In case of spill; wash the place where any chemical has been spilt with available spill kit.
- 16.8. Take care to prevent leakage due to ejection from valves, fittings, flanges, or other joints flexible chemical hoses and pumps. Never repair the equipment during transfer into mixing tank/container.
17. Take reading of Shut in / Flowing Tubing Head Pressure (SI/F/THP), Casing Head Pressure (CHP) and fluid sample (if available) prior to operation.
18. Check gas lift condition and capability with Site Operation Representative (SOR).
19. Ensure fitness prior to perform duties assigned.
20. Ensure all barriers are in place and followed.

HEALTH, SAFETY & ENVIRONMENT

1. Evaluate possible risks to arise during the job execution.
2. Evaluate risk assessment. Report any abnormal or insecure condition on site, taking into account all the steps or procedures to follow. Discuss with PCSB HSE coordinator, the execution or suspension of the job.
3. Review SDS of each product that will be used. Verify that all personnel on location handling toxic or corrosive products have the proper PPE.
4. Review the contingency plan for spills.
5. Do not vent / release any hydrocarbons from the well to atmosphere. Returns from the well should be handled safely by Flowback Company.
6. Prior to DB personnel walking on upper deck, DB Supervisor to inspect upper deck and ensure that the area it is in good condition (Gratings, Hatches, etc.)

Prepared By: Muhammad hafiz	Reviewed By: Kung Yee Han	Date: 20/3/2024	Rev. Rev3	Controlled Document DB-CT-MHS-230238	Pg. 17
--------------------------------	------------------------------	--------------------	--------------	---	-----------

DIMENSION BID	DIMENSION BID COILED TUBING SERVICES		
	DULANG C-4 S	CEMENT PACKER	

EQUIPMENT RIG UP PROCEDURE

Conduct safety meeting with all personnel on location detailing the program, pressure limitations, and personnel responsibilities, well control emergency drill and safety precautions.

1. Spot the equipment accordingly to space availability, ensure reel position is aligned with the well.
2. Spot jacking frame at available space with sufficient height and crane capacity to rig up the injector head and gooseneck.
3. Rig up the 4" LP hoses from fluid storage tanks to batch mixer and single pump unit
4. Rig up 2" HP treating line as per DB Technical Standard from single pump unit and N2 converter unit to CT reel manifold. Include bleed off line on both lines as well.
5. Install correct wellhead crossover on the wellhead. Ensure well is fully secure and record the MV and CV turns.
6. Install Blowout Preventer (BOPs):
 - 6.1. Rig up Single BOP with necessary length of risers on top of the wellhead crossover.
 - 6.2. Rig up Combi BOP with flow tee above the risers
 - 6.3. Hook up BOP hoses and conduct function test for each ram.
7. Rig up 2" kill line from single pump unit line to BOP kill port.
8. Rig up flow back line from flow tee to Choke manifold -> desander unit -> High pressure flowback pump -> Donor Well (Refer process flow Diagram for Dual line rig-up to the donor well).
9. Spot injector head assembly (c/w stripper) with jacking frame on top of wellhead area. Ensure the gooseneck is aligned with the reel position
10. Inspect the chain and gripper block condition and ensure the alignment is correct
11. Rig up the following hydraulic hoses:
 - 11.1. From CT Power Pack to CT Control Cabin
 - 11.2. From CT Power Pack to CT Injector hose reel
 - 11.3. From CT Control Cabin to CT Reel
 - 11.4. From CT Control Cabin to CT BOPs
 - 11.5. From CT Power Pack to Jacking Frame
12. Perform EMC 1 for all equipment. Start up and run all equipment for few minutes.
13. Jack up CT control cabin.
14. Function test both BOP rams.

*Observe indicator pin to confirm that all rams are in good working condition.
15. Install the stab-in-guide on the CT then stab the string into injector head.
16. Record the total cut length of CT String in Cerberus and Pipe Management for future reference.
17. Make up the CT connector and perform pull test at least 15,000 lbs as per DB SOP. This test to be recorded in OrionNET.

*Do not perform pull test more than 80% from CT Limit.
18. Install pressure test plate onto the CT connector.
19. Circulate the string with water until clean return is seen prior to proceed with pressure test CT Connector.
20. Pressure up the CT string to 5,000 psi gradually by 500 psi increment then hold for 10 minutes.

Prepared By: Muhammad hafiz	Reviewed By: Kung Yee Han	Date: 20/3/2024	Rev. Rev3	Controlled Document DB-CT-MHS-230238	Pg. 18
--------------------------------	------------------------------	--------------------	--------------	---	-----------

21. Open the needle valve to release the pressure slowly.
22. Flush coil to ensure there is no debris/metal inside the treating line or coil, and perform Coil pickling (7.5% HCl).

Notes: All acid will be neutralized at surface line before flowback to system.

23. Make up the BHA onto the string as per BHA diagram provided.
24. Use the jacking frame to pick up the injector and risers then connect to the Combi BOP. Secure down the injector assembly with chains.
25. Measure the following length to set the CT depth:

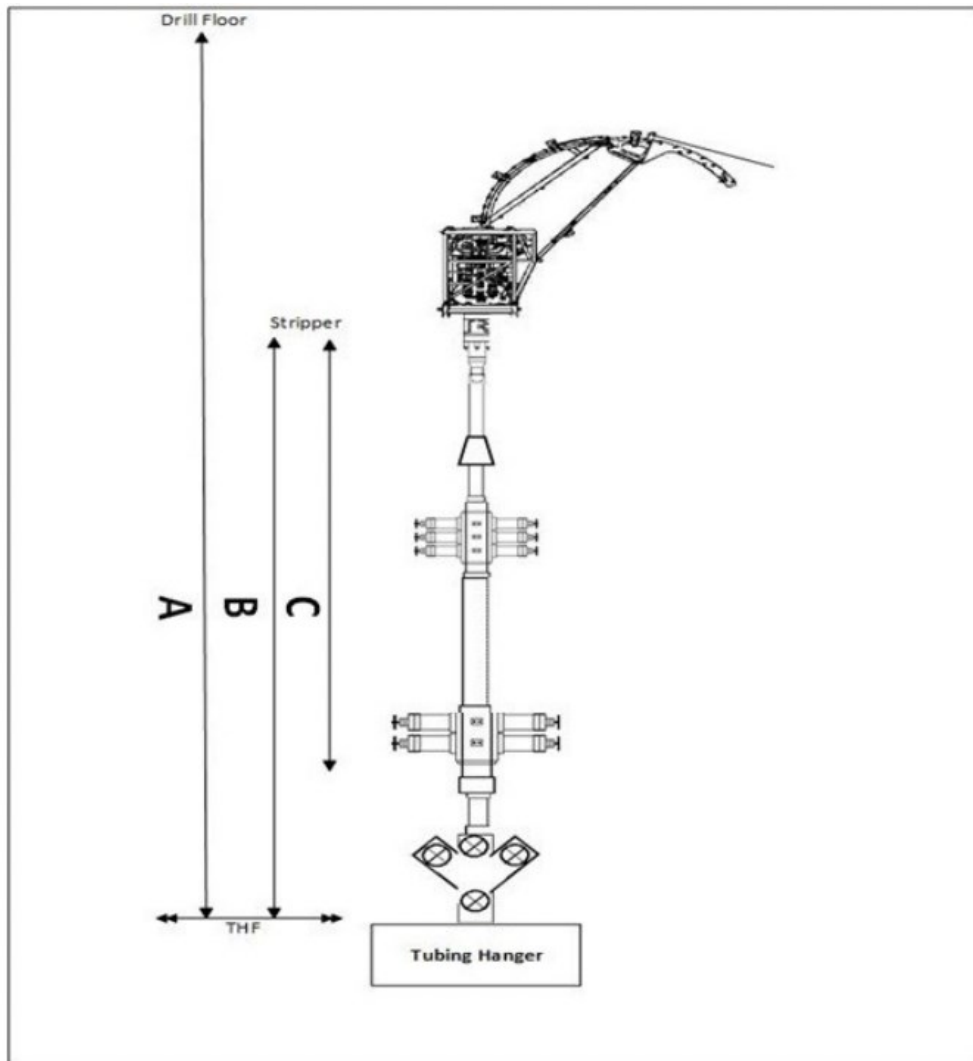

Distance	Length (ft)
A: Tubing Hanger (THF) to RKB	
B: Tubing Hanger (THF) to Stripper	
C: BHA Length	

26. Pick up CT and tag the stripper to set CT depth based on this calculation "A-B+C".

DIMENSION BID	DIMENSION BID COILED TUBING SERVICES		
	DULANG C-4 S	CEMENT PACKER	

EQUIPMENT PRESSURE TESTING PROCEDURE

Conduct safety meeting with all personnel on location detailing the program, pressure limitations, and personnel responsibilities, well control emergency drill and safety precautions. Refer the following procedure to pressure test BOP Body, Blind Ram, Surface Line and Wellhead connection.

1. Isolate the line to CT. Double confirm the valve is closed.
2. Fill and pressure test the treating line with water to 500 psi and hold for 5 minutes. Inspect the lines for leaks and observe for any pressure drop.
3. Increase pressure to 3,000 psi and hold for 10 minutes. Inspect the lines for leaks and observe for any pressure drop.
4. Fill the pressure control equipment and ensure air is vented from the system by leaving the blind ram and blind ram equalizing valves open.
5. Close blind ram and equalizing valve. Pressure up the surface lines, BOP body, blind rams and wellhead connection to 500 psi then increase gradually to 3,000 psi through the kill line, hold for 10 minutes. Inspect the lines for leaks and observe for any pressure drop.
6. Once test complete, open blind ram pressure equalizing port then bleed off any residual pressure and open the blind rams.

Conduct safety meeting with all personnel on location detailing the program, pressure limitations, and personnel responsibilities, well control emergency drill and safety precautions. Refer the following procedure to pressure test BOP Body, Blind Ram, Surface Line and Wellhead connection.

1. Fill up the CT string and stack up until leak can be seen at stripper.
2. Energize the stripper and begin pressure test the complete stack up (CT string, stripper, CT stack and risers) to 3,000 psi against Crown Valve, hold for 10 minutes.
3. Bleed off pressure inside stack up to 1,500psi and bleed off pressure inside CT to 0psi immediately to test the Double Flapper Check Valve with DP of 1,500psi and hold for 10 minutes.
4. Bleed off the pressure from BOP kill port side.

*Step 4-8 can be neglected if pipe ram has been pressure tested prior to the job.
5. Place CT string across pipe ram then close the ram.
6. Open pipe ram equalizing valve then fill up the BOP slowly.
7. Close the equalizing valve and begin pressure test the pipe ram to 3,000 psi, hold for 10 minutes.
8. When the tests are complete, bleed off the pressure.

Prepared By: Muhammad hafiz	Reviewed By: Kung Yee Han	Date: 20/3/2024	Rev. Rev3	Controlled Document DB-CT-MHS-230238	Pg. 20
--------------------------------	------------------------------	--------------------	--------------	---	-----------

OPERATIONAL PROCEDURE

CT RUN#3: DEPTH CORRELATION / DRIFT RUN

1. After make-up connector, launch Cement Dart at pig launcher.
2. Pump and push cement dart to sit at the connector, record the volume. (Once dart sit at connector, there will be increase in circulation pressure.)
3. Apply and slowly increase pumping pressure, expected pumping pressure to burst the Cement dart based on Dart Rating (2,500 psi).
4. Remove cement dart and proceed as per below.
5. Make up Depth correlation BHA as per **BHA#2: Depth Correlation** in **Appendix 1**.

NOTE: Take the BHA measurement and record in the DOR.

6. Perform function test of the Nozzle to determine the pumping parameter. Record the data in the table below, do not exceed 5,000psi.

Flow rates (bpm)	Pressure (psi)	Remark
... (as minimum as possible)		
0.3		
0.5		
0.7		
1.0		
1.1		
1.3		
... (as maximum as possible)		

7. Box up to connect the riser and prepare for pressure test.
8. Pick up CT and tag BHA with the stripper.
9. CT stack up pressure test against Wellhead Crown valve. Pumping treated sea water through the CT, apply low pressure test of **300 psi for 5 minutes** and high-pressure test of **3,000 psi for 15 minutes** after stabilization. Record the pressure test. Record test on a chart. Upon successful pressure test, bleed off pressure via Pump-In Sub.
 - 9.1. For low pressure:

Acceptance criteria: No visible leaks. Pressure drop is less than 10% (above 270 psi) over 5-minutes test interval after the pressure stabilizes.
 - 9.2. For high pressure:

Acceptance criteria: No visible leaks. Pressure drop is less than 10% (above 2,700 psi) over the 15- minutes test interval after the pressure stabilizes.
10. Pressure tests the BHA Check Valve. With **3,000 psi** in the CT stack up, bleed off the stack up pressure to **1,500 psi** via pump-in sub; and bleed off pressure in the CT to zero (0) psi via reel manifold.
 - 10.1. Acceptance criteria: **Pressure drop is less than 10% (above 1,350 psi) over the 15- minute test interval after the pressure stabilizes.** Observe for any pressure changes in the stack up. If the BHA check valve is not holding, proceed to replace the MHA; do not RIH with leaking check valve; repeat steps 7 and 8.

11. Upon successful test, bleed off the pressure in the CT stack up to zero through the pump-in sub.
12. Zero both depth counters (Orion and Mechanical) at reference point.
13. Confirm all wellhead and BOP valves are in open position via physical check.
 - 13.1. Prior opening the wellhead valve, pressure up above master valves to a pressure equal to the expected shut-in wellhead pressure.
 - 13.2. Count and record wellhead valves turns while opening and record it the operation report for reference in future.

CV Opening Turns	LMV Opening Turns

- 13.3. Record initial SITHP and all annulus pressure (PCP, ICP, SCP etc) in the Daily Operation Report (DOR).
- 13.4. Manipulate surface valve to the following position:

Valve	Position
Reel Manifold	OPEN
Flow Cross Return Valve (Cetco lines)	OPEN
Wing Valve	CLOSE
A-Annulus Valve (PCP)	CLOSE

14. Start RIH BHA dry run until tag modified cement retainer set at SSD#2 area 2,173m / 7,130 ft MDTHF (change in depth subject to actual modified cement retainer setting depth).
 - 14.1. Refer to CT Tubing Force simulation (Orpheus modelling), refer **Appendix III**.
 - 14.2. Conduct pull test as per for every 300m (1,000ft), use CT Fatigue graph as reference. [Ensure the CT Fatigue graph is available at location before RIH. Record RIH, Hanging and POOH weight in treatment report.](#)
 - 14.3. Break circulation every 1,000 ft (2bbls TFW)
 - 14.4. Pump friction reducer solution, 2 bbls as lubricant if encounter high dragging (if required).
 - 14.5. Maximum CT RIH speed is **30-50 ft/min/ 9-10m/min**.
 - 14.6. Slow down coil speed to **10 ft/min/ 3m/min**, 50 ft / 15m before and after passing through completion accessories.
 - 14.7. Closely observe weight indicator in control cabin while RIH.
 - 14.8. Observe return all the times.
 - 14.9. Do not exceed operating safety limits **5,000 psi (Circulating pressure)**.
 - 14.10. If the well condition differs from original job design, contact appropriate personnel in charge before proceeding.
 - 14.11. At all time, while RIH, the injector torque control shall be set at the minimum pressure required to move the CT at specified speed.
15. Once BHA reached 10m above modified cement retainer Setting depth 2,173m / 7,130 ft MDTHF, stop coil and conduct pull test of 10m/30ft and record the pulling weight both static and dynamic.

Depth	RIH weight, lbf	Static weight, lbf	Pick up weight, lbf

16. Continue RIH to tag top of modified cement retainer (for the maximum allowable setdown weight, kindly refer to the TFA graph, do not exceed 50% from the maximum allowable set down weight, consult

DIMENSION BID	DIMENSION BID COILED TUBING SERVICES		 PETRONAS
	DULANG C-4 S	CEMENT PACKER	

Weatherford specialist advice on maximum allowable setdown applied on the modified cement retainer). Tag **twice** to confirm the depth.

17. Once confirm, flag CT string on surface, Flag#1. (reset depth if required)
18. Pick-up to CT packer setting depth at 2,168m, Flag#2. (flag at cement retainer setting depth,5m above top of cement retainer)
19. RIH to 2m CT last tag depth (Flag#1), Jet at max rate with THP below 400 psi to clean completion tubing walls to be ready for CT packer setting (2,000m – 2,173m).
20. On completion of high-rate jetting, POOH to BHA to surface.

Prepared By: Muhammad hafiz	Reviewed By: Kung Yee Han	Date: 20/3/2024	Rev. Rev3	Controlled Document DB-CT-MHS-230238	Pg. 23
--------------------------------	------------------------------	--------------------	--------------	---	-----------

CT RUN#4: CEMENTING OPERATION

1. Perform pumping calibration test at surface prior for operation. (Ensure pump rate/ volume at pump, tally with DAS at cabin and volume inside the storage tank)
NOTE: During the cementing operation, in the event pump rate doesn't tally with DAS, to always use volume inside the supply tank as reference.
2. Make up CT Packer BHA as per **BHA#3: Cementing** in **Appendix 1**.
NOTE: Take the BHA measurement and record in the DOR.
3. Perform function test of the Nozzle to determine the pumping parameter. Record the data in the table below, do not exceed 5,000psi.

Flow rates (bpm)	Flowrate (scfm) (if applicable)	Pressure (psi)	Remark
... (as minimum as possible)			
0.3			
0.5			
0.7			
1.0			
1.1			
1.3			
... (as maximum as possible)			

4. Box up to connect the riser and prepare for pressure test.
5. Pick up CT and tag BHA with the stripper.
6. CT stack up pressure test against Wellhead Crown valve. Pumping treated sea water through the CT, apply low pressure test of **300 psi for 5 minutes** and high-pressure test of **3,000 psi for 15 minutes** after stabilization. Record the pressure test. Record test on a chart. Upon successful pressure test, bleed off pressure via Pump-In Sub.
 - 6.1. For low pressure:
Acceptance criteria: No visible leaks. Pressure drop is less than 10% (above 270 psi) over 5-minutes test interval after the pressure stabilizes.
 - 6.2. For high pressure:
Acceptance criteria: No visible leaks. Pressure drop is less than 10% (above 2,700 psi) over the 15- minutes test interval after the pressure stabilizes.
7. Pressure tests the BHA Check Valve. With **3,000 psi** in the CT stack up, bleed off the stack up pressure to **1,500 psi** via pump-in sub; and bleed off pressure in the CT to zero (0) psi via reel manifold.
 - 7.1. Acceptance criteria: **Pressure drop is less than 10% (above 1,350 psi) over the 15- minute test interval after the pressure stabilizes.** Observe for any pressure changes in the stack up. If the BHA check valve is not holding, proceed to replace the MHA; do not RIH with leaking check valve; repeat steps 7 and 8.
8. Upon successful test, bleed off the pressure in the CT stack up to zero through the pump-in sub.
9. Zero both depth counters (Orion and Mechanical) at reference point.
10. Confirm all wellhead and BOP valves are in open position via physical check.

- 10.1. Prior opening the wellhead valve, pressure up above master valves to a pressure equal to the expected shut-in wellhead pressure.
- 10.2. Count and record wellhead valves turns while opening and record it the operation report for reference in future.

CV Opening Turns	LMV Opening Turns

- 10.3. Record initial SITHP and all annulus pressure (PCP, ICP, SCP etc) in the Daily Operation Report (DOR).
- 10.4. Manipulate surface valve to the following position:

Valve	Position
Reel Manifold	OPEN
Flow Cross Return Valve (Cetco lines)	OPEN
Wing Valve	CLOSE
A-Annulus Valve (PCP)	CLOSE

11. Start RIH BHA dry run until at 10 ft above flag#1 depth, Modified cement retainer setting depth at area 2,173m / 7,130 ft MDTHF. (Notes: any changes in CT packer setting depth, subject to client approval/discussion after CT Run#3 Dummy run)
 - 11.1. Refer to CT Tubing Force simulation (Orpheus modelling), refer **Appendix III**.
 - 11.2. Conduct pull test as per for every 300m (1,000ft), use CT Fatigue graph as reference. Ensure the CT Fatigue graph is available at location before RIH. Record RIH, Hanging and POOH weight in treatment report. Break circulation as well.
 - 11.3. Break circulation every 1,000 ft (2 bbls).
 - 11.4. In the event of Jay mechanism activated during pull test, RIH to cycle the packer to release it (As per advice by Weatherford Toolman onboard).
 - 11.5. Pump friction reducer solution, 2 bbls as lubricant if encounter high dragging (if required).
 - 11.6. Maximum CT RIH speed is **30-50 ft/min/ 9-10m/min**.
 - 11.7. Slow down coil speed to **10 ft/min/ 3m/min**, 50 ft / 15m before and after passing through completion accessories.
 - 11.8. Closely observe weight indicator in control cabin while RUG
 - 11.9. Observe return at all times.
 - 11.10. Do not exceed operating safety limits **5,000 psi (circulating pressure)**.
 - 11.11. If the well condition differs from original job design, contact appropriate personnel in charge before proceeding.
 - 11.12. At all time, while RIH, the injector torque control shall be set at the minimum pressure required to move the CT at specified speed.
12. Once BHA reached 15 m above CT packer setting depth, stop coil and conduct pull test of 10m/30ft and record the pulling weight both static and dynamic.

Depth	RIH weight, lbf	Static weight, lbf	Pick up weight, lbf

13. Once BHA at 10 ft from previous flag#1 depth, stop coil. Proceed to mix 5 bbls of contaminated gel. Pump 3 bbls of contaminated gel. Once gel fluid outside nozzle, continue pick-up BHA until 5 ft below leak at tubing (2,002.5 m MDTHF) to spot the contaminated gel.

(Notes: - Ensure to close PCP return line, and flow cross return line is open at surface.)

Contaminated Gel				420	gals	10	bbls	Description
Seq	Product	Concentration		Volume				
1	Sea Water	944	gptg	397	gals	9.4	bbls	Base Fluid
2	SCR	50	gptg	21	gals	0.5	bbls	Cement retarder
3	Gel	41	pptg	17	lbs			Gelling agent

Mixing Instruction:

1. Fill up tank with sea Water
2. Add additives as per above sequence
3. Agitate until mixture is homogeneous

14. Once complete pump, RIH until 5 ft above CT packer setting depth (proposed depth at 2,168m MDTHF, any changes in depth subject to discussion and approval from client and town). Once CT in tension condition, proceed to set the CT packer as per Weatherford procedure below.
15. Active the Jay mechanism, once observed overpull (anchor at tubing), apply 3,000 lbs overpull (downhole) to set the CT packer.
16. Once confirmed CT packer already set, perform pressure test 500 psi for 30 minutes, if pressure test fail, re-set the CT packer (2-m above the initial position) and re-do the pressure test.
17. After obtained approval from client and town, proceed as per below step.
18. Increase pumping pressure slowly until burst the pump out plug at modified cement retainer (rating – 1,000 psi). Once burst, proceed to pump 20 bbls gel follow with 1x (Tubing + A – Annulus volume) – 460 bbls of TSW to displace the contaminated gel into the A – Annulus (Notes: - Ensure to Open PCP return line, and flow cross return line is closed at surface.)

Treated sea water (TSW)				100	BBL	Description
Seq.	Product	Concentration		Volume		
1	Sea Water	994	gptg	4,175	gal	Base Fluid
2	ACM H2S Clear 200	2	gptg	8	gal	CO2 & H2S Corrosion Inhibitor
3	ACM BACT 200	2	gptg	8	gal	Micro Biocide Control
4	ACM OXYFREE 100	2	gptg	8	gal	Oxygen Scavenger

Mixing Instruction:

- a) Prepare Sea Water into the mixing tank.
- b) Add ACM H2S Clear 200 into the tank and circulate the mixture.
- c) Add ACM BACT 200 & ACM OXYFREE 100 into the tank and circulate the mixture until homogenous.

19. During this pumping stage, perform injectivity test/circulation test as per below table.

Rate (bpm)	Pump Pressure (psi)	Time (min)	Volume (bbl)	THP (psi)	PCP (psi)	SCP (psi)	ICP (psi) if available
... (as minimum as possible)							
0.5							
0.7							

DIMENSION BID

DIMENSION BID COILED TUBING SERVICES



DULANG C-4 S

CEMENT PACKER

1.0							
1.5							
2.0							
2.5							
3.0							
3.5							
.... (as maximum as possible)							

20. After completed pumping, share injectivity/circulation test operating parameters with town before proceeding with next step.
21. Conduct job specific meeting between technical support team (base/office) and operation team (onshore)
22. Proceed to mix 35 bbls of 15 ppg cement as per below while continue pumping TFW through coil tubing at idle rate.

15ppg Cement			1470	gals	35	bbls
Products	Concentration		Volume			
Sea Water	3.815	gps	609.01	gals	14.50	bbl
SFP 0006 (Foam Preventer)	0.05	gps	7.98	gals	0.19	bbl
SBA 0016 (Bonding Agent)	1.55	gps	247.43	gals	5.89	bbl
SFL 0016 (Fluid Loss)	0.15	gps	23.95	gals	0.57	bbl
SCD 0003 (Cement Dispersant)	0.2	gps	31.93	gals	0.76	bbl
SCR 0024 (Cement Retarder)	0.06	gps	9.58	gals	0.23	bbl
Blended Slagment with 12.5% Silica	1.231	cuft/sk	11,760.29	lbs	213.8	55 lbs per sacks
Expanding agent	0.5%	bwoc	58.8	lbs		
<ol style="list-style-type: none"> 1. Fill up batch mixer with sea water 2. Add additives as per above sequence 3. Note the time when 1st cement sack is added into mixed water mixture. Thickening time starts once 1st cement sacks is added into mixed water. 4. Refer to Appendix 5 for cement lab test results 						
Note:						
<ol style="list-style-type: none"> 1. Record and inform Engineer in Charge when the first sack of cement is added to mixed water mixture. 2. Cement Thickening Time is 15 hours 58 minutes from first sack of cement added. 3. Cement Mixing Time is 2 hours and additional safety margin 1 hour. 4. Total Cement Mixing Cut-Off Time is 3 hours. 5. After complete mixing, take cement sample from Batch Mixer and CT Reel Manifold and keep sample for monitoring. Label sample properly. 						

23. Upon complete mixing and density witness and confirmation of WSS, begin to pump cement according to the following steps: -
 - 23.1. Take sample at surface, put into two conditions, one at surface temperature and another sample at reservoir temperature.
 - 23.2. Open overboard valve and flush surface lines with cement slurry until neat cement is observed.
 - 23.3. Reset data acquisition before start pumping.
 - 23.4. Close overboard valve and equalize pressure across reel valve
 - 23.5. Ensure wellhead valves are configured according to table below: -

Valve	Position
Reel Manifold	OPEN
Flow Cross Return Valve (Cetco lines)	CLOSE
Wing Valve – Short String	CLOSE
A-Annulus Return Line	OPEN

23.6. Start pumping according to pumping sequence specified below (assume CT Volume 18.8 bbls), maximum pumping rate subject to circulation pressure, based on weatherford simulation result, maximum pressure allowable 2,100 psi for 15 ppg cement fluid: -

#	Start Depth (ft)	End Depth (ft)	Fluid at Reel Manifold	Fluid Entry Volume (bbl)	Total Fluid Pumped (bbl)	Pump Rate (bpm)	CT Speed (ft/min)	Fluid at Nozzle	Valves Config.	Remarks
									SS	
1	7,110	7,110	TSW	5	5	0.5	-	TSW	Close	Reset DAS Volume
2	7,110	7,110	Install lead cement dart (3,000 psi Cement dart rating), Green color							
3	7,110	7,110	Cement	18.8	23.8	0.3 – 1.0	-	TSW	Close	Cement at tip of nozzle, reduce pump rate to 0.3 bpm once 0.5 bbls before Dart land at connector
4	7,110	7,110	Once observe Circulation pressure increase, applied at least 1,610 psi pumping pressure to burst the Cement dart							
5	7,110	7,110	Cement	7.2	31	0.3 – 1.0	-	Cement	Close	Cement at tip of nozzle
6	7,110	7,110	Install Tail cement dart (2,000 psi cement dart rating), White color							
7	7,110	7,110	TSW	18.8	49.8	0.3 – 1.0	-	TSW	Close	All 26 bbls cement outside of nozzle, reduce pump rate to 0.3 bpm once 0.5 bbls before Dart land at connector
8	7,110	7,110	Once Observe circulation pressure increase, Stop pumping. Open Flow cross return valve, applied at least 2,070 psi pumping pressure to burst the tail cement dart							
9	7,110	7,110	Once tail cement dart burst, pump 0.25 bbls TSW to push cement enter cement retainer, and follow Weatherford procedure to release the CT Packer, once release follow as per step below.							
10	7,110	7,110	Contamination Gel	5	54.8	0.3	0	TSW	Open	-

11	7,110	7,110	TSW	13.8	68.6	0.3	0	Contaminated Gel	Open	Contaminated gel at Nozzle.
12	7,110	6,247	TSW	5	73.6	0.3	52	TSW	Open	Spot Contaminated gel, 5 bbls
13	6,247	6,147	TSW	10	83.6	Max Rate	10	TSW	Open	Pick-up CT 100 ft above top of Contaminated Gel
14	6,147	7,170	TSW	23	106.6	Max Rate	45	TSW	Open	RIH back to 30 ft above top of CR
15	7,170	7,170	Gel	10	116.6	Max Rate	-	TSW	Open	Circulate out excess cement in Coil and Tubing. Reciprocate CT during circulate gel.
17	7,170	7,170	TSW	84	200.6	Max Rate	-	TSW	Open	Bottom Up until at least 2x tubing volume or clear return. Reciprocate CT during bottoms up.
18	7,170	7,170	Contamination Gel	5	205.6	1.0	-	TSW	Open	Fill up CT with Gel
19	7,170	7,170	TSW	13.8	219.4	1.0	-	Contaminated Gel	Open	Fill up CT with SW and displace 0.5 gel out of nozzle
20	7,170	6,271	TSW	4.5	296	0.3	54	TSW	Open	POOH CT while spot gel.
21	6,271	0	TSW	-	-	Max Rate	20 - 30	TSW	Open	Continue POOH to surface

1. Actual CT string volume will be confirmed during rig up.
2. (-) refers to CT moving upward / pick up coil
3. During Pumping cement and displacement fluid, Field Engineer / Cementer / WSS / CT Supv to verify and witness the fluid level inside batch mixer
4. **DO NOT EXCEED** pumping pressure of 2,200 psi during cementing stage, **(based on Weatherford CT packer limitation).**

24. Proceed POOH coil to surface: -
- 24.1. Pump treated seawater with minimum rate of 0.3bpm. (Go Max rate to circulate out the fluid to surface)
 - 24.2. Maximum coil speed while POOH is 50ft/min.
 - 24.3. Slow down coil speed to 10ft/min 50ft before and after passing through completion accessories.
 - 24.4. Do not exceed CT operating limit (refer to Appendix Section: TFA simulation)

DIMENSION BID	DIMENSION BID COILED TUBING SERVICES		 PETRONAS
	DULANG C-4 S	CEMENT PACKER	

25. Once CT reaches at surface:
 - 25.1. Close master and swab valve.
 - 25.2. Flush pumping line, coil string and BHA with TSW to clean excess cement.
 - 25.3. Service all BHA and prepare for next run.
26. Wait on cement for completely hardened after 23 hours from 1st cement sack added.

Prepared By: Muhammad hafiz	Reviewed By: Kung Yee Han	Date: 20/3/2024	Rev. Rev3	Controlled Document DB-CT-MHS-230238	Pg. 30
--------------------------------	------------------------------	--------------------	--------------	---	-----------

CT RUN#5: CLEANOUT UNTIL TOP OF CEMENT RETAINER (2,170 m / 7,119 ft MDTHF)

Conduct safety meeting with all personnel on location detailing the program, pressure limitations, personnel responsibilities, emergency well control drill, and safety precautions. Ensure tubing pickling already performed prior for Acid wash job.

1. Make up 1-11/16" Spincat as per **BHA#4: 1-11/16" Spincat** in **Appendix 1**.
NOTE: Take the BHA measurement and record in the DOR.
2. Perform function test of the Spincat to determine the pumping parameter. Record the data in the table below, do not exceed 5,000psi.

Flow rates (bpm)	Flowrate (scfm)	Pressure (psi)	Remark
... (as minimum as possible)			
0.3			
0.5			
0.7			
1.0			
1.1			
1.3			
... (as maximum as possible, below 5,000 psi)			

3. Box up to connect the riser and prepare for pressure test.
4. Pick up CT and tag BHA with the stripper.
5. CT stack up pressure test against Wellhead Crown valve. Pumping treated sea water through the CT, apply low pressure test of **300 psi for 5 minutes** and high-pressure test of **3,000 psi for 15 minutes** after stabilization. Record the pressure test. Record test on a chart. Upon successful pressure test, bleed off pressure via Pump-In Sub.
 - 5.1. For low pressure:
Acceptance criteria: No visible leaks. Pressure drop is less than 10% (above 270 psi) over 5-minutes test interval after the pressure stabilizes.
 - 5.2. For high pressure:
Acceptance criteria: No visible leaks. Pressure drop is less than 10% (above 2,700 psi) over the 15- minutes test interval after the pressure stabilizes.
6. Pressure tests the BHA Check Valve. With **3,000 psi** in the CT stack up, bleed off the stack up pressure to **1,500 psi** via pump-in sub; and bleed off pressure in the CT to zero (0) psi via reel manifold.
 - 6.1. Acceptance criteria: **Pressure drop is less than 10% (above 1,350 psi) over the 15- minute test interval after the pressure stabilizes.** Observe for any pressure changes in the stack up. If the BHA check valve is not holding, proceed to replace the MHA; do not RIH with leaking check valve; repeat steps 7 and 8.
7. Upon successful test, bleed off the pressure in the CT stack up to zero through the pump-in sub.
8. Zero both depth counters (Orion and Mechanical) at reference point.
9. Confirm all wellhead and BOP valves are in open position via physical check.

- 9.1. Prior opening the wellhead valve, pressure up above master valves to a pressure equal to the expected shut-in wellhead pressure.
- 9.2. Count and record wellhead valves turns while opening and record it the operation report for reference in future.

CV Opening Turns	LMV Opening Turns

- 9.3. Record initial SITHP and all annulus pressure (PCP, ICP, SCP etc) in the Daily Operation Report (DOR).
- 9.4. Manipulate surface valve to the following position:

Valve	Position
Reel Manifold	OPEN
Flow Cross Return Valve (Cetco lines)	OPEN
Wing Valve	CLOSE

10. Start RIH BHA while pumping TSW at 1 bpm once a depth **1,900m / 6,234ft**, if still not encounter HUD, start to perform cleanout until Cement retainer depth, 2,170m/7,119 ft MDTHF.
 - 10.1. Refer to CT Tubing Force simulation (Orpheus modelling), refer **Appendix III**.
 - 10.2. Conduct pull test for every 300m (1,000ft) interval, use CT Fatigue graph as reference. Ensure the CT Fatigue graph is available at location before RIH. Record RIH, Hanging and POOH weight in treatment report.
 - 10.3. Pump drag reducer solution, 2 bbls as lubricant if encounter high dragging (if required).
 - 10.4. Maximum CT RIH speed is **30-50 ft/min/ 9-10m/min**.
 - 10.5. Slow down coil speed to **10 ft/min/ 10m/min**, 50 ft / 15m before and after passing through completion accessories.
 - 10.6. Closely observe weight indicator in control cabin while RIH.
 - 10.7. Observe return all the times.
 - 10.8. Do not exceed operating safety limits **5,000 psi (Circulating pressure)**.
 - 10.9. If the well condition differs from original job design, contact appropriate personnel in charge before proceeding.
 - 10.10. At all time, while RIH, the injector torque control shall be set at the minimum pressure required to move the CT at specified speed.
11. Once BHA reached 1,990 m, stop coil and conduct pull test of 10m/30ft and record the pulling weight both static and dynamic. (If encounter early HUD, Pick-up BHA and record the weight parameter).

Depth	RIH weight, lbf	Static weight, lbf	Pick up weight, lbf

DIMENSION BID	DIMENSION BID COILED TUBING SERVICES		
	DULANG C-4 S	CEMENT PACKER	

12. Increase Jetting rate and establish circulation

Rate suggest by CIRCA: -

- 1 bpm with 300 scfm

Notes:

- **For Gas rate minimum at 300 scfm, maximum up to 4,600 psi circulation pressure.**
- **After establish constant return at surface, divert the flow into surge tank for 15 – 30 minutes, record the volume inside the surge tank to calculate losses rate into reservoir. Repeat this step every time change in choke size (due to several reason such as high and low THP).**
- **Continuously record return volume during cleanout operation. (Record inside improved FDR)**
 - 12.1.1. For the event of lost return, kindly refer to the step below for reference:
 - 12.1.1.1. Check surface flowback back pressure. Must be less than WHP
 - 12.1.1.2. Wait till system stabilizes
 - 12.1.1.3. Check gas lift injection
 - Is it on?
 - Injection pressure > Wellbore pressure?
 - 12.1.1.4. Manipulate choke size
 - 12.1.2. If still no return at surface, pick-up BHA by stages to establish return. (Proposed to depth where returns were previously obtained.
 - 12.1.3. If no return establishes at surface, consult town. (Provide the details of THP, choke size and circulation pressure).
 - 12.1.4. After return establish, RIH to perform cleanout.
 - 12.1.5. At all times, monitor the return pattern, THP and debris sample at surface. (Take note if there any THP drop during penetration).
 - 12.1.6. **If no debris recover at surface while penetrating HUD with fluid return, stop penetration and circulate with Gel and CBU until debris recover at surface.**
 - 12.1.7. **Pump 5 bbls gel to lift the suspected debris to surface.**
 - 12.1.8. **CBU at least 2x Annulus volume at that depth.**
 - 12.1.9. **After confirm there's no longer debris at that depth, proceed penetration.**
 - 12.1.10. **In the event unable to penetrate due to hard solid, slowly increase jetting rate until maximum allowable during penetration (ensure the return always establish at surface), after complete 1 cycle penetration, follow rate suggest by CIRCA to lift up the debris.**
 - 12.1.11. **If require to divert the return into the donor well, follow as per step below: -**
 - 12.1.11.1. **Bleed down THP donor well to 0psi or as minimum as possible before start CT operation.**
 - 12.1.11.2. **Continue to monitor the THP for both donors well, in the event of THP build up, continue to bleed the pressure, (If unable to bleed due to hydrocarbon return at surface, proceed to pump TSW to push the gas/hydrocarbon into formation. (Based on injectivity test trending, able to reduce THP of the well after pumping TSW into the well (higher THP due to low fluid level inside the well)**
 - 12.1.11.3. **If unable to bleed to zero, apply slightly higher pressure in injection line to overcome THP donor well.**

Prepared By: Muhammad hafiz	Reviewed By: Kung Yee Han	Date: 20/3/2024	Rev. Rev3	Controlled Document DB-CT-MHS-230238	Pg. 33
--------------------------------	------------------------------	--------------------	--------------	---	-----------

12.1.11.4. Manipulate surface return valves, and open the pumping line to the Donor Well as per process flow diagram

12.1.11.5. Running water and spill kit to be made available at the following location: pumping unit and suction and discharge flowback pump.

12.1.11.6. Do not exceed calculated MASTP as per below: -

WELL	Completion + Tubing Volume	1.5 Completion + Tubing Volume	Pump Rates	MASTP	A-Annulus Volume above first packer, bbl.
	(bbl)	bbls	(BPM)	(psi)	
C23 L	93	139	0.5 – 3.0	820	301
C23 S	53	80	0.5 – 3.0	820	301
C08 S	104	156	0.5 – 3.0	820	425
C28 S	70	104	0.5 – 3.0	820	360

Notes: MASTP is calculated using 70% of fracture pressure gradient and completion tubing filled with TSW

12.1.11.7. In the event of primary Donor well unable to accept injection fluid due to formation tight/plugged (or other issues), switch to inject into secondary Donor well.

12.1.11.8. To address switching activity on surface to secondary Donor Well, CT subsurface activity at primary well to revert by picking up BHA to safe depth (low deviation section, 40 deg @ 410m).

12.1.11.9. Station CT at 1,814m while maintain pumping parameter. Rig down from #1 Donor well and rig up to alternative #3 Donor well.

12.1.11.10. After complete pressure test surface line #3 Donor well, resume CT cleanout activity at primary well.

13. Every 30m bite, circulate with 5 bbls of gel, until BHA at Cement retainer depth, 2,170m/7,119 ft MDTHF.

No.	Stage	Fluid	Liquid Rate (Vary)	Total Liquid	N2 Rate	CT Speed	Duration	Depth	Remarks
			BPM	BBL	SCFM	ft/min	Minute	m	
1	CT at 10 m above HUD	TSW	1		300 (minimum)	0	0	10 m above HUD	Establish return on surface
2	RIH to HUD and Penetrate HUD/Fill	TSW	1		300 (minimum)	10	10	HUD + 30 m	Monitor return & CT weight on surface
3	Circulate	D801 Gel	1	5	300 (minimum)	0	13	Stationary CT	Provide suspension to the fill and lift to surface
4	Circulation	TSW	1		300 (minimum)	0	30 (expected to arrive at surface)	Stationary CT	Until gel return at surface, once confirm the return is clean, proceed with next step as per below.

DIMENSION BID	DIMENSION BID COILED TUBING SERVICES		
	DULANG C-4 S	CEMENT PACKER	

Pull Test 10m									
5	RIH to last HUD and Penetrate HUD/Fill	TSW	1		300 (minimum)	10	10	HUD + 30 m	Monitor return & CT weight on surface
6	Circulate	D801 Gel	1	5	300 (minimum)	0	13	Stationary CT	Provide suspension to the fill and lift to surface
7	Circulation	TSW	1		300 (minimum)	0	30 (Expected to arrive at surface)	Stationary CT	Until gel return at surface, once confirm the return is clean, proceed with next step as per below.
Pull Test 10m									
Repeat above step 1 to 7 until reached Cement retainer setting Depth, 2,170m/7,119 ft MDTHF									
7	Hole Cleaning (Circulate)	D801 Gel	1	20	300 (minimum)	0		Stationary CT @ 5 m above Cement Retainer	Hole cleaning stage.
8	Bottoms Up (Circulate)	TSW	1		300 (minimum)	0	60	Stationary CT @ 5 m above Cement Retainer	Hole Cleaning stage. 2 Hour CBU
Once completed CBU and clear return is established, flag#2 at surface.									
9	POOH	TSW	1 – 0.5		300 (minimum)	10 – 30		To Surface	Monitor return on surface

14. Once at target depth, flag CT string on surface.
15. Remaining stationary and proceed to pump 20 bbls of gel followed with CBU for 2 hours (as per CIRCA analysis).
16. Once complete CBU, start to wiper trip up and POOH to surface
17. Wiper trip speed suggested base on CIRCA analysis **5 ft/min**, until depth 1,900 m. After that continue to POOH normal speed **30-50 ft/min/ 9-10m/min**.
18. Reciprocate with high rate across SPM at least twice.
19. Once at surface, prepare for next run.

Prepared By: Muhammad hafiz	Reviewed By: Kung Yee Han	Date: 20/3/2024	Rev. Rev3	Controlled Document DB-CT-MHS-230238	Pg. 35
--------------------------------	------------------------------	--------------------	--------------	---	-----------

CT RUN#6: CT UNLOADING

- Make up upward nozzle as per **BHA#5: Unloading Tool** in **Appendix 1**.
NOTE: Record BHA measurement in the DOR.
- Perform function test of the Nozzle to determine the pumping parameter. Record the data in the table below, do not exceed 5,000psi.

Flow rates (bpm)	Pressure (psi)	Remark
... (as minimum as possible)		
0.3		
0.5		
0.7		
1.0		
1.1		
1.3		
... (as maximum as possible)		

- Box up to connect the riser and prepare for pressure test.
- Pick up CT and tag BHA with the stripper.
- CT stack up pressure test against Wellhead Crown valve. Pumping treated sea water through the CT, apply low pressure test of **300 psi for 5 minutes** and high-pressure test of **3,000 psi for 15 minutes** after stabilization. Record the pressure test. Record test on a chart. Upon successful pressure test, bleed off pressure via Pump-In Sub.
 - For low pressure:
Acceptance criteria: No visible leaks. Pressure drop is less than 10% (above 270 psi) over 5-minutes test interval after the pressure stabilizes.
 - For high pressure:
Acceptance criteria: No visible leaks. Pressure drop is less than 10% (above 2,700 psi) over the 15- minutes test interval after the pressure stabilizes.
- Pressure tests the BHA Check Valve. With **3,000 psi** in the CT stack up, bleed off the stack up pressure to **1,500 psi** via pump-in sub; and bleed off pressure in the CT to zero (0) psi via reel manifold.
 - Acceptance criteria: **Pressure drop is less than 10% (above 1,350 psi) over the 15- minute test interval after the pressure stabilizes.** Observe for any pressure changes in the stack up. If the BHA check valve is not holding, proceed to replace the MHA; do not RIH with leaking check valve; repeat steps 7 and 8.
- Upon successful test, bleed off the pressure in the CT stack up to zero through the pump-in sub.
- Flush CT String empty with N2. Circulate return direct to the flowback facility. Do not circulate into wellbore.
- Zero both depth counters (Orion and Mechanical) at reference point.
- Confirm all wellhead and BOP valves are in open position via physical check.
 - Prior opening the wellhead valve, pressure up above master valves to a pressure equal to the expected shut-in wellhead pressure.

10.2. Count and record wellhead valves turns while opening and record it the operation report for reference in future.

CV Opening Turns	LMV Opening Turns

10.3. Record initial SITHP and all annulus pressure (PCP, ICP, SCP etc) in the Daily Operation Report (DOR).

10.4. Manipulate surface valve to the following position:

Valve	Position
Reel Manifold	OPEN
Flow Cross Return Valve (Cetco lines)	OPEN
Wing Valve	CLOSE

11. Start RIH BHA while pumping nitrogen at minimum rate until arrive first **300m** below.

11.1. Refer to CT Tubing Force simulation (Orpheus modelling), refer **Appendix III**.

11.2. Conduct pull test as per for every 300m (1,000ft), use CT Fatigue graph as reference. Ensure the CT Fatigue graph is available at location before RIH. Record RIH, Hanging and POOH weight in treatment report. Break circulation as well.

11.3. Pump drag reducer solution, 2 bbls as lubricant if encounter high dragging (if required).

11.4. Maximum CT RIH speed is **30-50 ft/min/ 9-10m/min**.

11.5. Slow down coil speed to **10 ft/min/ 10m/min**, 50 ft / 15m before and after passing through completion accessories.

11.6. Closely observe weight indicator in control cabin while running in hole.

11.7. Observe return all the times.

11.8. Do not exceed operating safety limits **5,000 psi (Circulating pressure)**.

11.9. If the well condition differs from original job design, contact appropriate personnel in charge before proceeding.

11.10. At all time, while RIH, the injector torque control shall be set at the minimum pressure required to move the CT at specified speed.

12. Once BHA reached first 300m, stop coil and conduct pull test and record both pulling weight both static and dynamic of CT.

Depth	RIH weight, lbf	Static weight, lbf	Pick up weight, lbf

13. Increase pump rate to 400 scfm, station for 30 minutes or until no water return at surface.

14. Proceed to next 300m and repeat step 13 until arrive at depth 2,000m.

15. Once arrive at depth 2,000m station BHA for 1 hour. Continue circulation until no return observed at surface.

16. Once observe only gas return at surface, start to POOH while maintain pump 300 scfm all the way to surface.

17. Handover to E-Line once at surface.

DIMENSION BID

DIMENSION BID COILED TUBING SERVICES



DULANG C-4 S

CEMENT PACKER

APPENDIX I – BHA SCHEMATIC

BHA#1: 1-11/16 SpinCAT Nozzle

DIMENSION BID

BHA DIAGRAM #1 - 1.69" SPINCAT NOZZLE

Client	Petronas Carigali
Field	Dulang C
Job Type	
Job No.	Run#1,2

Well	C-4S
Min Restriction	2.25"
BHP	
BHT	212 deg F

BHA DRAWING	DESCRIPTION	CONNECTION		ID	OD	TOOL LENGTH	CUMULATIVE LENGTH
		UPHOLE	DOWNHOLE				
	External Dimple Connector	1.5" CT	1.5" AMMT PIN		2.125	0.3	0.3
	MHA Disconnect drop ball 3/4"	1.5" AMMT BOX	1.5" AMMT PIN		2.125	2.3	2.6
	Circulating drop ball 5/8" Burst Disc 5000 psi						
	Crossover	1.5" AMMT BOX	1.0" AMMT PIN		2.125	1.0	3.6
	3 ft Straight Bar	1.0" AMMT BOX	1.0" AMMT PIN		1.690	3.0	6.6
	Downhole Filter	1.0" AMMT BOX	1.0" AMMT PIN		1.690	3.2	9.80
	SpinCat	1.0" AMMT BOX			1.690	1.0	10.8

BHA LENGTH	10.80
MAXIMUM OD	2.125"
MINIMUM ID	

BHA#2: Depth Corelation / Drift Run



Client	Petronas Carigali
Field	Dulang C
Job Type	
Job No.	Run#3

Well	C-4S
Min Restriction	2.25"
BHP	
BHT	

BHA DRAWING	DESCRIPTION	CONNECTION		ID	OD	TOOL LENGTH	CUMULATIVE LENGTH						
		UPHOLE	DOWNHOLE					INCH	INCH	FT	FT		
	External Dimple CT Connector (weatherford)	1.5" CT	1.5" AMMT PIN		2.000	0.4	0.4						
	2 -1/8" MHA (weatherford) Disconnect drop ball 0.75" 3 - Pin = 2,700 psi Circulating drop ball 0.63" 2 - Pin = 2,800 psi Burst Disc 5000 psi	1.5" AMMT BOX	1.5" AMMT PIN		2.125	2.2	2.6						
	5 ft Straight bar	1.5" AMMT BOX	1.5" AMMT PIN		2.125	5.00	7.64						
	5 ft Straight bar	1.5" AMMT BOX	1.5" AMMT PIN		2.125	5.00	12.64						
	Nozzle	1.5" AMMT BOX			2.125	1.0	13.64						
	<table border="1" style="margin-left: auto; margin-right: 0;"> <tr><td style="background-color: #92d050;">BHA LENGTH</td><td>13.64</td></tr> <tr><td style="background-color: #92d050;">MAXIMUM OD</td><td>2.125</td></tr> <tr><td style="background-color: #92d050;">MINIMUM ID</td><td></td></tr> </table>								BHA LENGTH	13.64	MAXIMUM OD	2.125	MINIMUM ID
BHA LENGTH	13.64												
MAXIMUM OD	2.125												
MINIMUM ID													

Prepared by:	Muhammad Hafiz
Review by:	
Revision:	
Date:	24/3/2022

ADDITIONAL INFORMATION:

BHA#3: Cementing



BHA DIAGRAM #3- CT Packer

Client	Petronas Carigali
Field	Dulang C
Job Type	
Job No.	Run#4

Well	C-4S
Min Restriction	2.25"
BHP	
BHT	

BHA DRAWING	DESCRIPTION	CONNECTION		ID	OD	TOOL LENGTH	CUMULATIVE LENGTH					
		UPHOLE	DOWNHOLE					INCH	INCH	FT	FT	
	External Dimple CT Connector (weatherford)	1.5" CT	1.5" AMMT PIN		2.000	0.4	0.4					
	2 - 1/8" MHA (weatherford) Disconnect drop ball 0.75" 3 - Pin = 2,700 psi	1.5" AMMT BOX	1.5" AMMT PIN		2.125	2.2	2.6					
	Circulating drop ball 0.63" 2 - Pin = 2,800 psi Burst Disc 5000 psi											
	Crossover	1.5" AMMT BOX	1.25 WTS 8- PIN		2.000	0.5	3.14					
	Setdown unloader	1.25 WTS 8- BOX	1.25 WTS 8- PIN		2.125	2.83	5.97					
	Crossover	1.25 WTS 8- BOX	1.5 WTS 8- PIN		2.125	0.5	6.47					
	Crossover	1.5 WTS 8- BOX	1.5 WTS 8- BOX		2.125	1.00	7.47					
	CT Packer Each - 2,050 lbs	1.5 WTS 8- PIN	1.5 WTS 8- BOX		2.250	4.60	12.07					
	Wash Nozzle	1.5 WTS 8- PIN			2.125	1.0	13.07					
<table border="1" style="margin-left: auto; border-collapse: collapse;"> <tr><td style="background-color: #92d050;">BHA LENGTH</td><td style="text-align: center;">13.07</td></tr> <tr><td style="background-color: #92d050;">MAXIMUM OD</td><td style="text-align: center;">2.250</td></tr> <tr><td style="background-color: #92d050;">MINIMUM ID</td><td></td></tr> </table>							BHA LENGTH	13.07	MAXIMUM OD	2.250	MINIMUM ID	
BHA LENGTH	13.07											
MAXIMUM OD	2.250											
MINIMUM ID												

BHA#4: 1-11/16 SpinCAT Nozzle

DIMENSION BID

BHA DIAGRAM #4 - 1.69" SPINCAT NOZZLE

Client	Petronas Carigali
Field	Dulang C
Job Type	
Job No.	Run#5

Well	C-4S
Min Restriction	2.25"
BHP	
BHT	212 deg F

BHA DRAWING	DESCRIPTION	CONNECTION		ID	OD	TOOL LENGTH	CUMULATIVE LENGTH
		UPHOLE	DOWNHOLE				
	Internal Dimple Connector	1.5" CT	1.0" AMMT PIN		1.690	0.3	0.3
	MHA Disconnect drop ball 5/8"	1.0" AMMT BOX	1.0" AMMT PIN		1.690	2.3	2.6
	Circulating drop ball 1/2"						
	Burst Disc 5000 psi						
	3 ft Straight Bar	1.0" AMMT BOX	1.0" AMMT PIN		1.690	3.0	5.6
	Downhole Filter	1.0" AMMT BOX	1.0" AMMT PIN		1.690	3.2	8.80
SpinCat	1.0" AMMT BOX			1.690	1.0	9.8	
BHA LENGTH						9.80	
MAXIMUM OD						1.69	
MINIMUM ID							

BHA#5: Unloading Tool



BHA DIAGRAM #5 - Nitrogen Unloading

Client	Petronas Carigali
Field	Dulang C
Job Type	
Job No.	Run#6

Well	C-4S
Min Restriction	2.25"
BHP	
BHT	

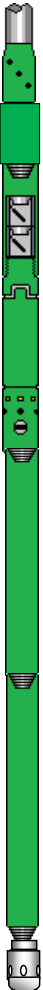
BHA DRAWING	DESCRIPTION	CONNECTION		ID	OD	TOOL LENGTH	CUMULATIVE LENGTH
		UPHOLE	DOWNHOLE				
	Dimple CT Connector	1.5" CT	1.0" AMMT PIN		1.690	0.6	0.6
	MHA Disconnect drop ball 5/8"	1.0" AMMT BOX	1.0" AMMT PIN		1.690	2.5	2.5
	Circulating drop ball 1/2"						
	Burst Disc 5000 psi						
	5 ft Straight bar	1.0" AMMT BOX	1.0" AMMT PIN		1.690	5.00	7.50
	3 ft Straight bar	1.0" AMMT BOX	1.0" AMMT PIN		1.690	3.00	10.50
	Upward Nozzle	1.0" AMMT BOX			1.690	1.00	11.50

BHA LENGTH	11.50
MAXIMUM OD	1.690
MINIMUM ID	

APPENDIX II – CT STACK UP

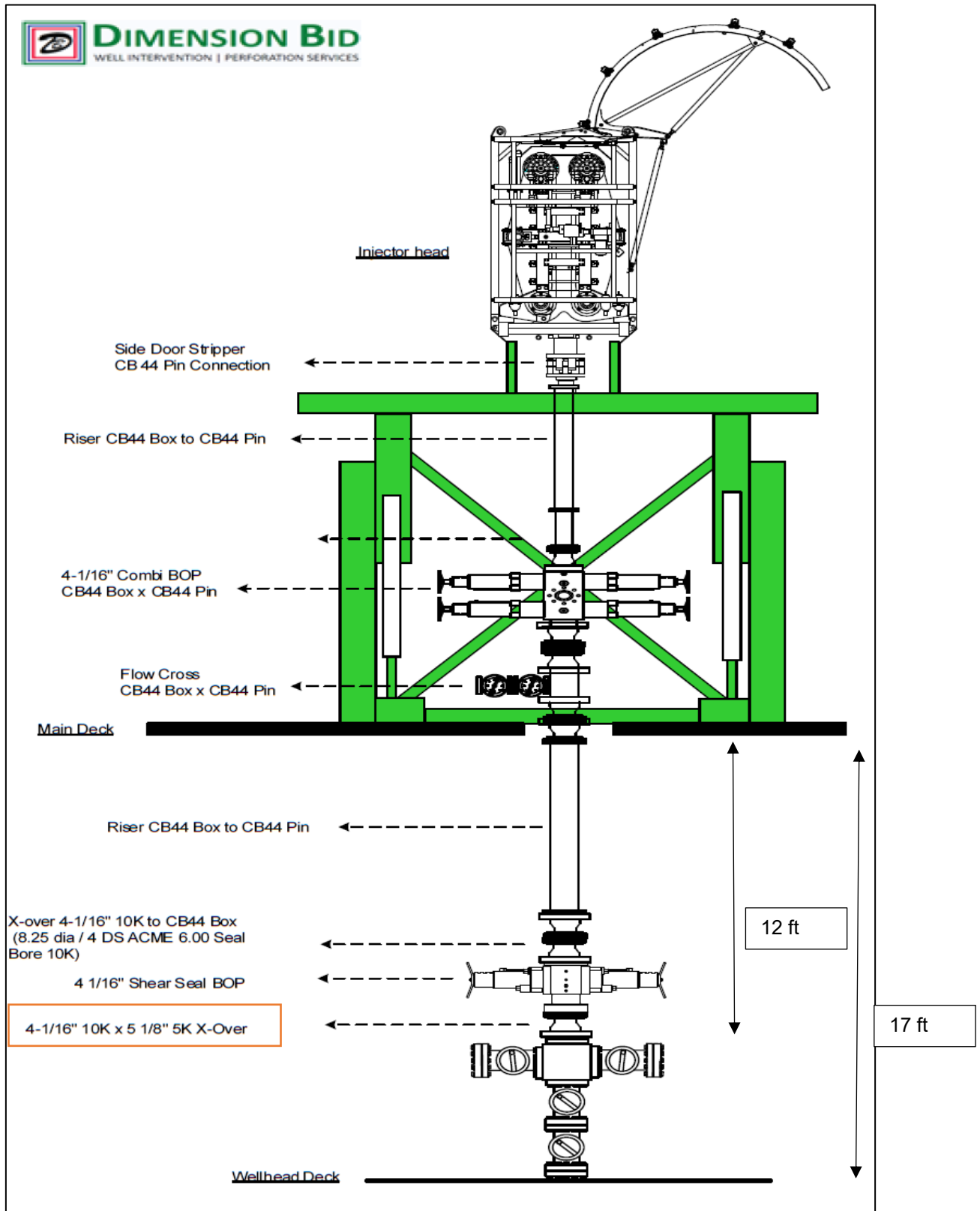

APPENDIX III – ORPHEUS SIMULATIONS

TUBING FORCE ANALYSIS UNTIL SSD#2 AREA

Graph(1)

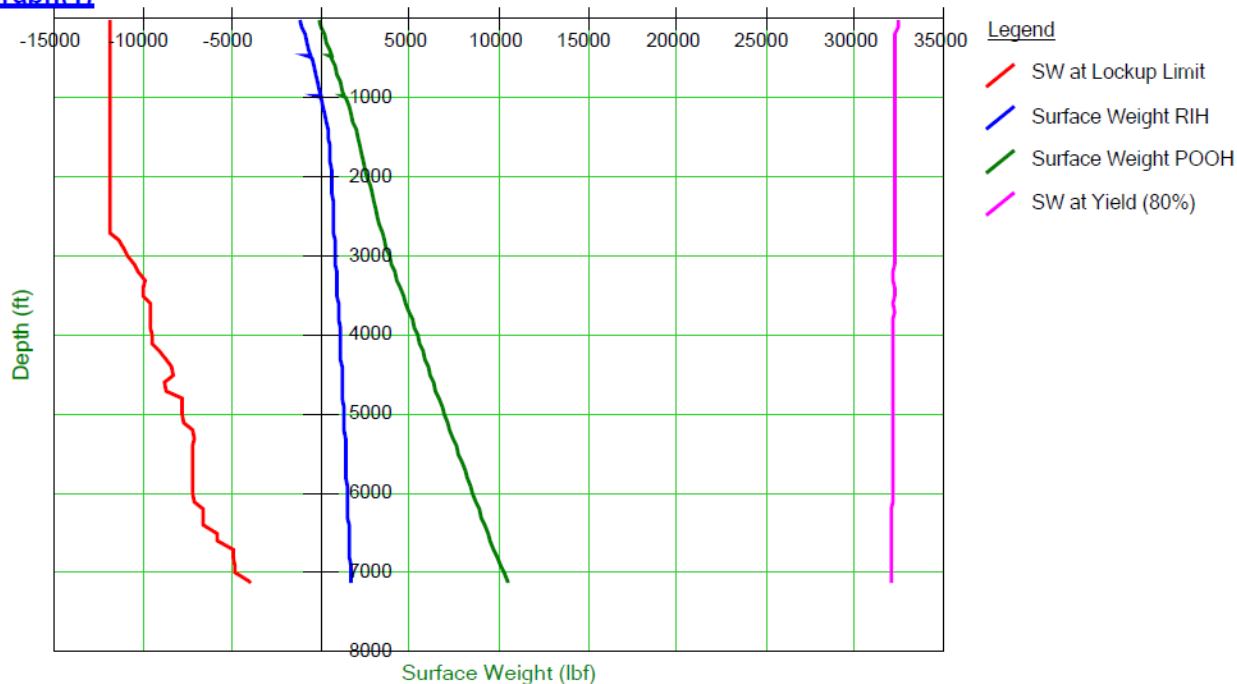

RIH & POOH WEIGHT

RIH and POOH

between 0 ft and 7130 ft

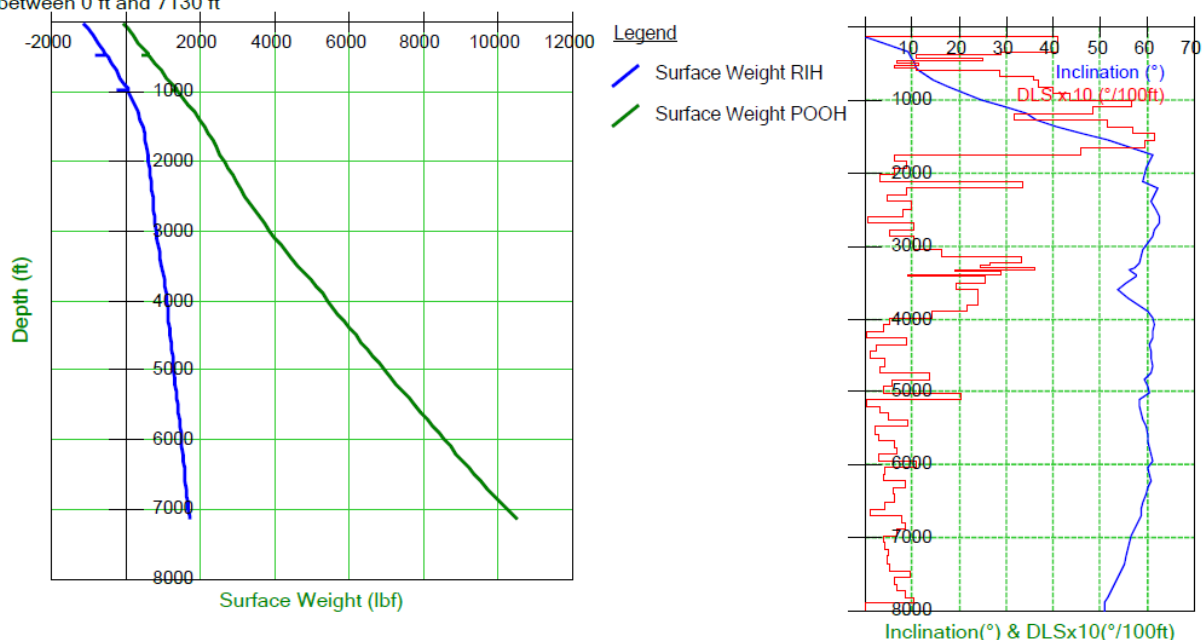

MAXIMUM STRING SET DOWN LIMIT

MD3 ■ The available set-down force at 7130 ft is -2677 lbf at the end of the string.
The weight indicator reading will be -3929 lbf on surface.

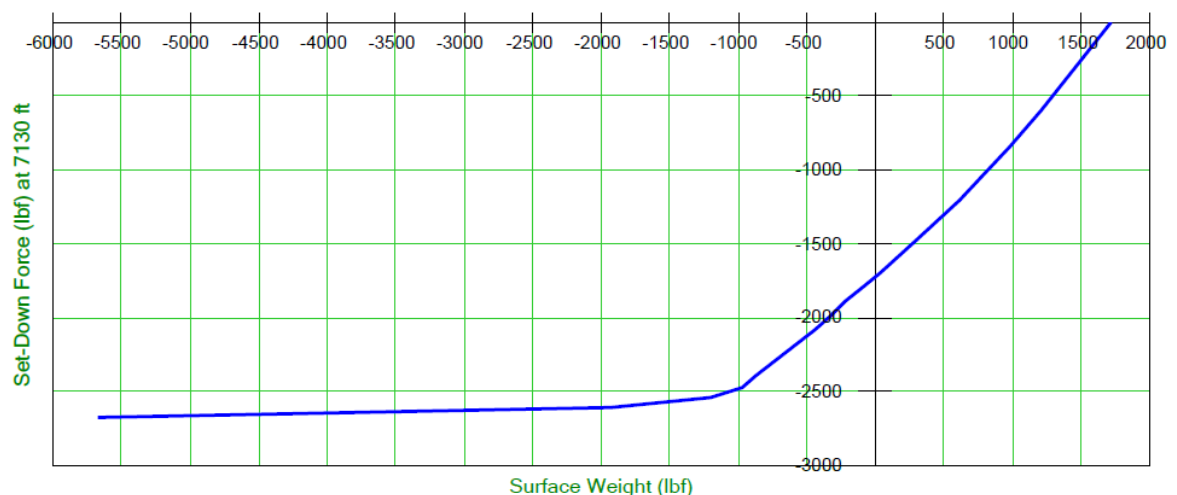

MAXIMUM STRING PICK UP LIMIT

Calculations at 7130 ft

MD1 ■ The available pick-up at 7130 ft based on 80% of yield strength is 12412 lbf.
The weight indicator reading will then be 31994 lbf.

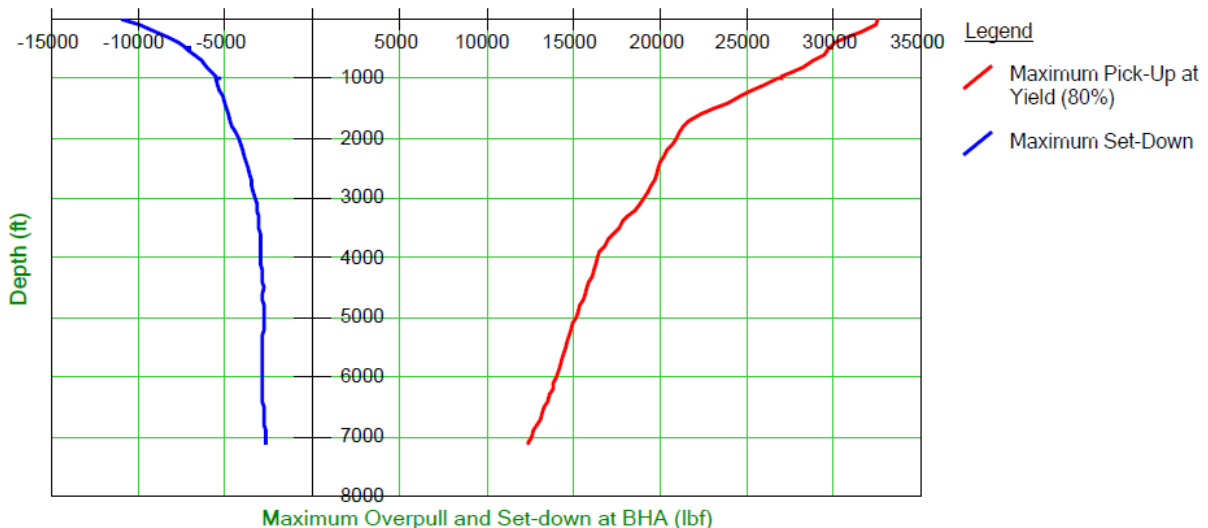

STRING LIMIT

CT Limits

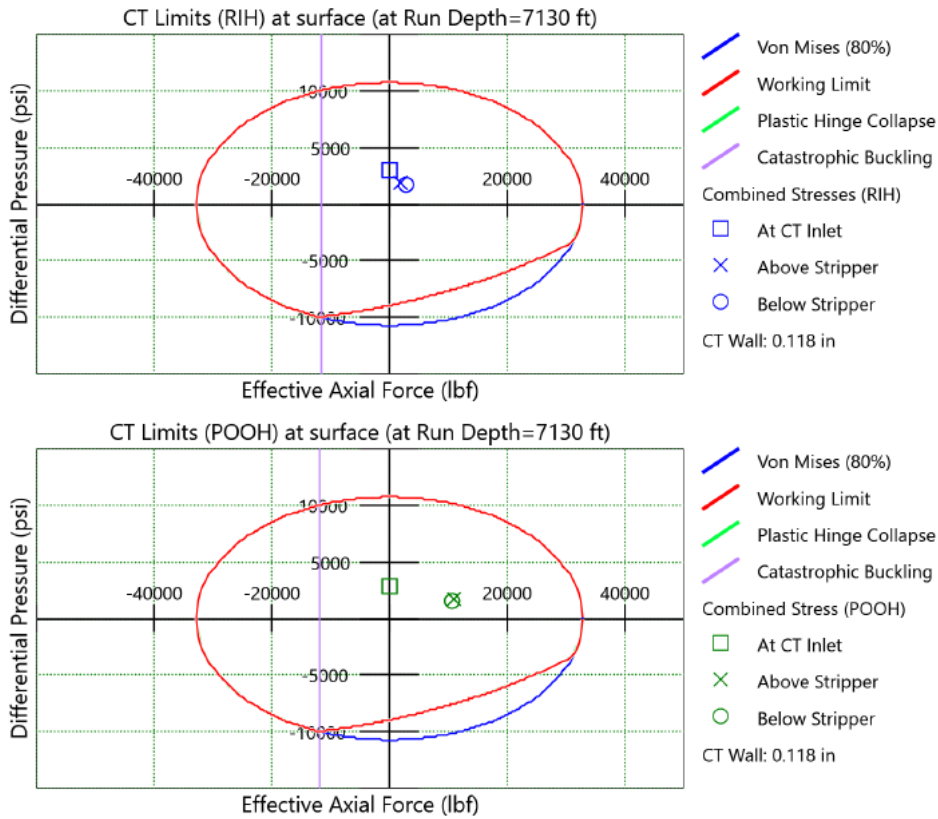

PICK-UP FORCE AT CR SETTING DEPTH

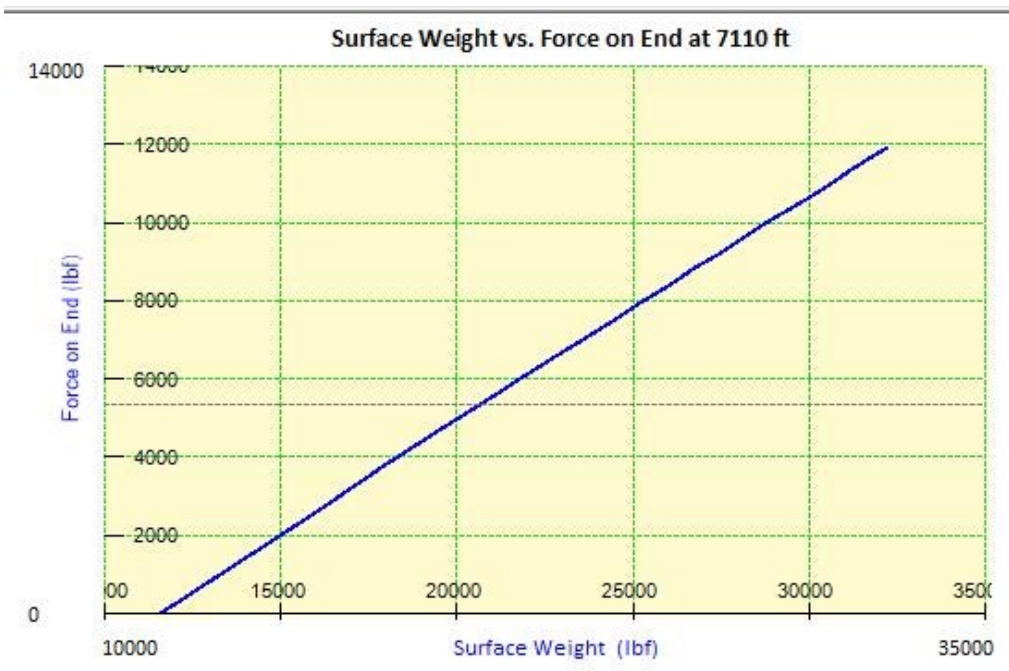

SENSITIVY ANALYSIS TFA

Zero RATE (0 bpm)

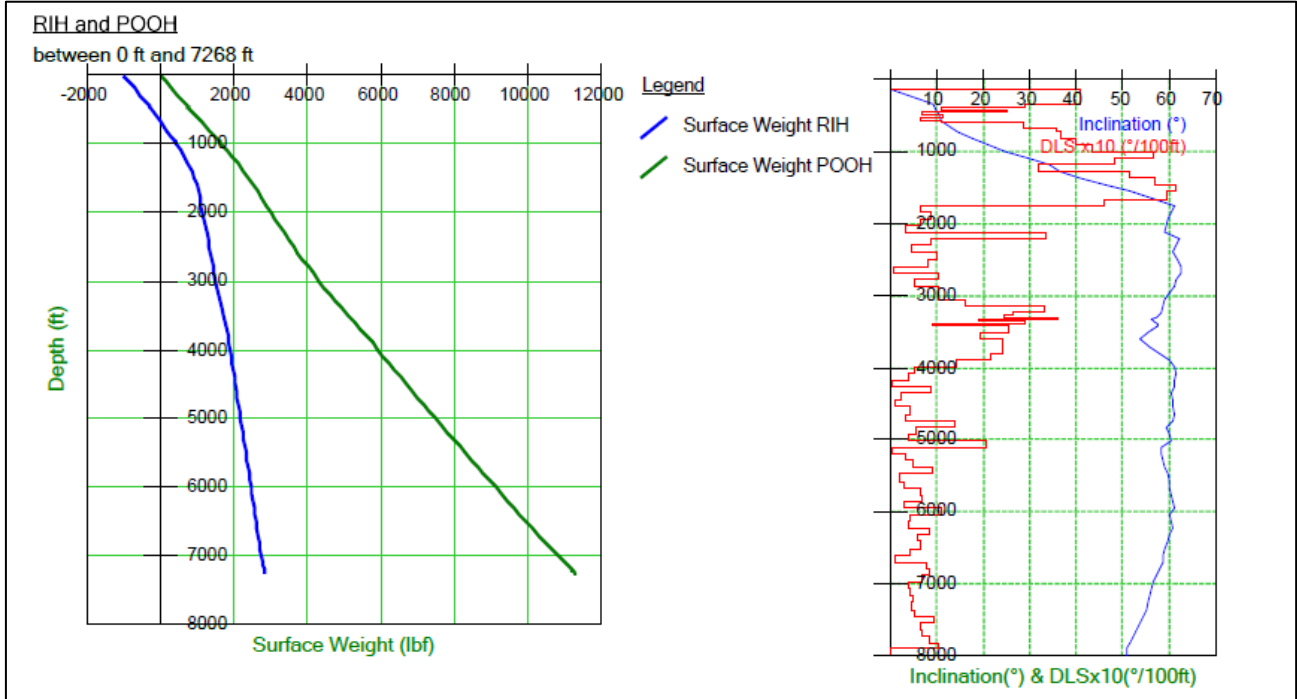

Idle Rate (0.3 bpm)

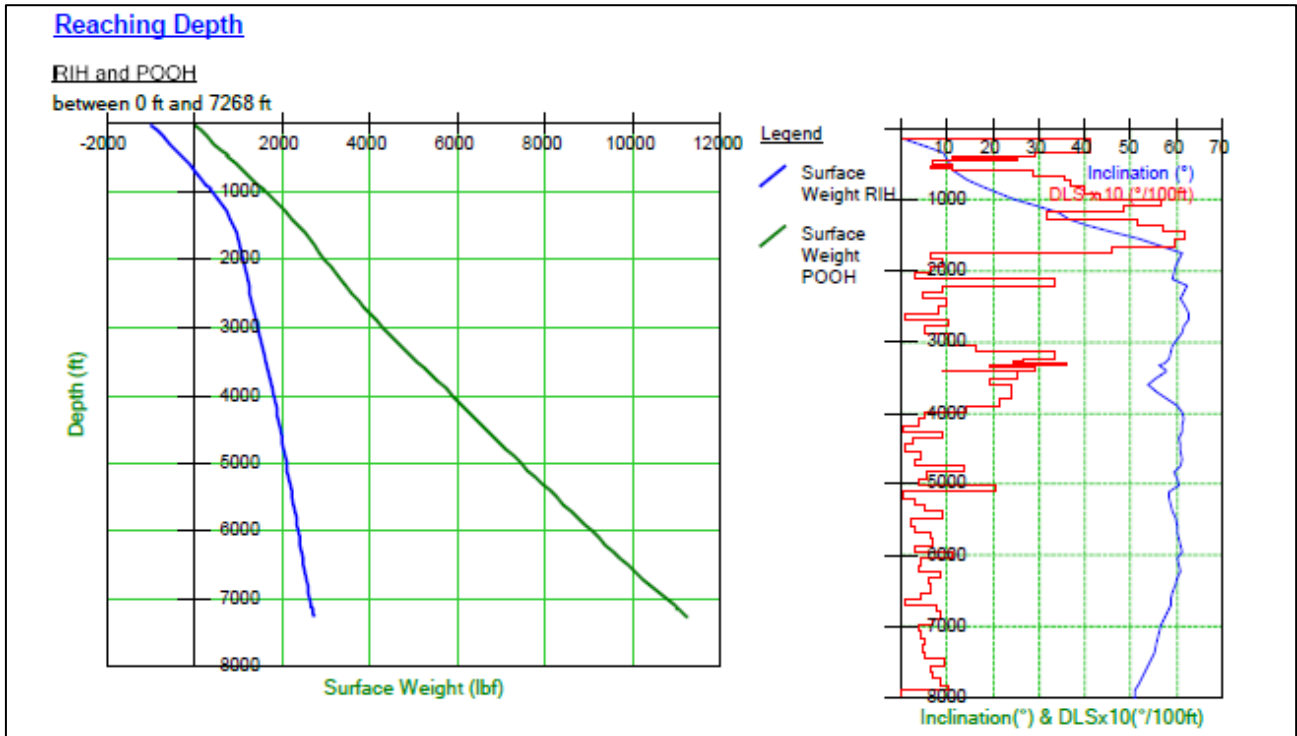

DIMENSION BID

DIMENSION BID
COILED TUBING SERVICES



DULANG C-4 S

CEMENT PACKER

High Rate (1 bpm)

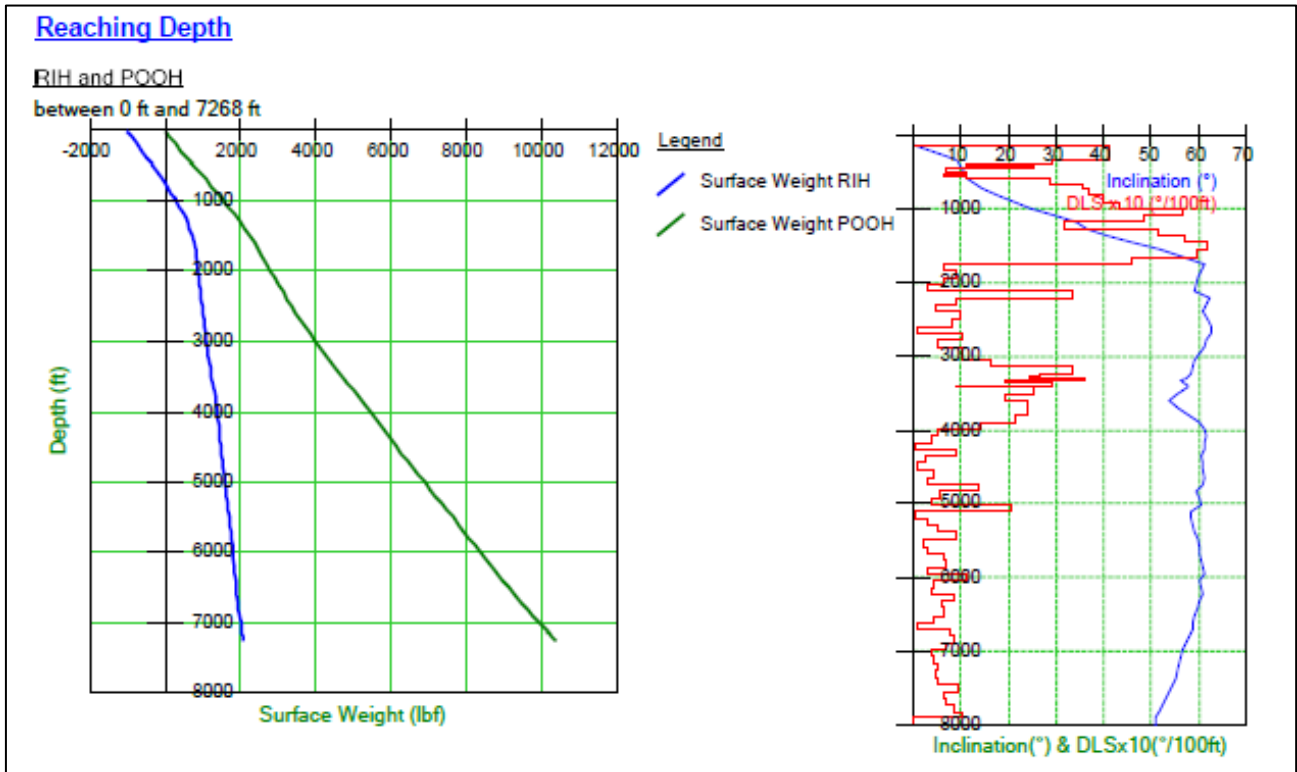

Nitrified (0.8 bpm 300 scfm)

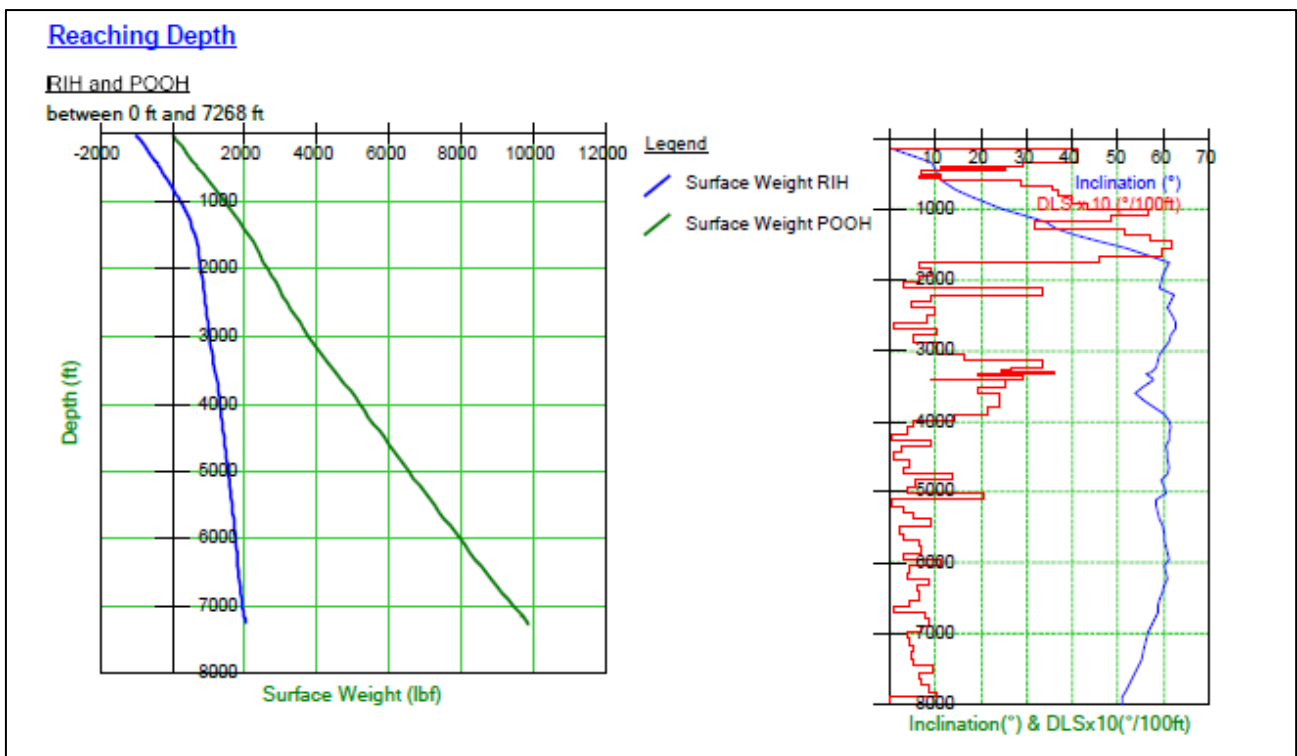

SENSITIVY ANALYSIS TFA

Friction Factor 0.2

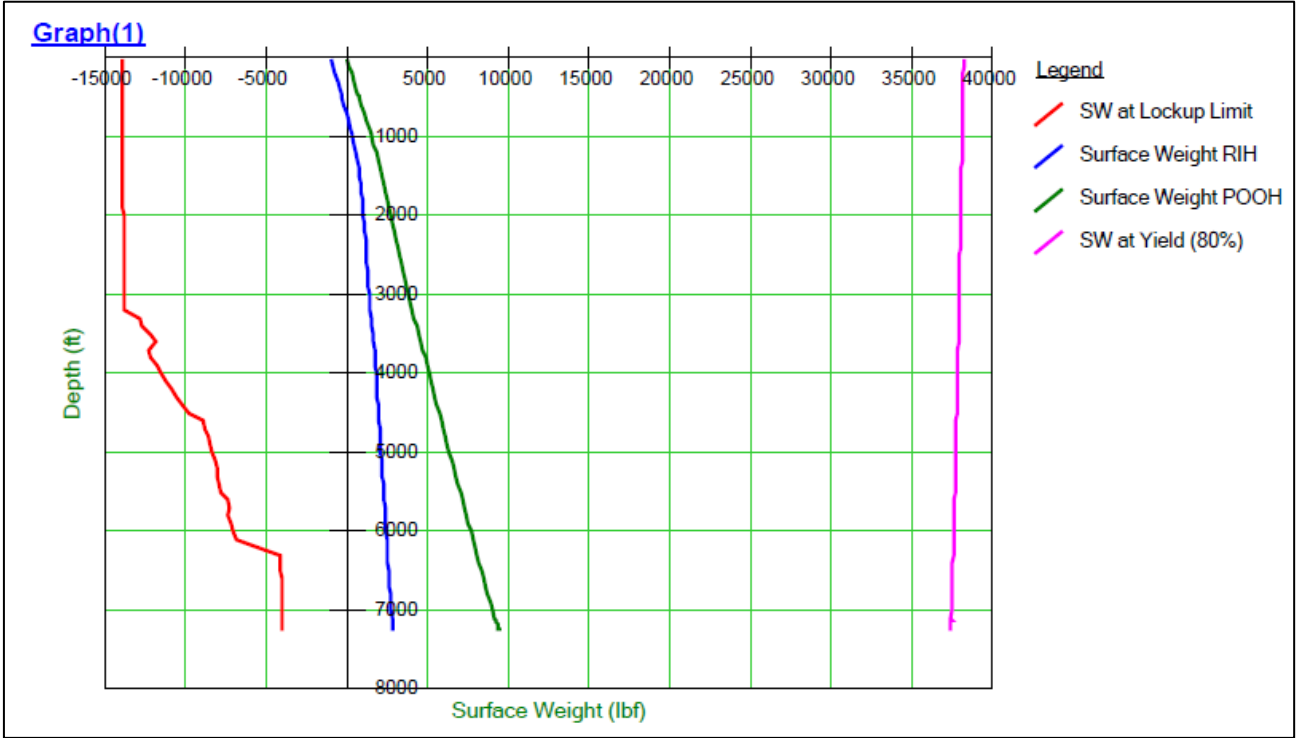

Friction Factor 0.25

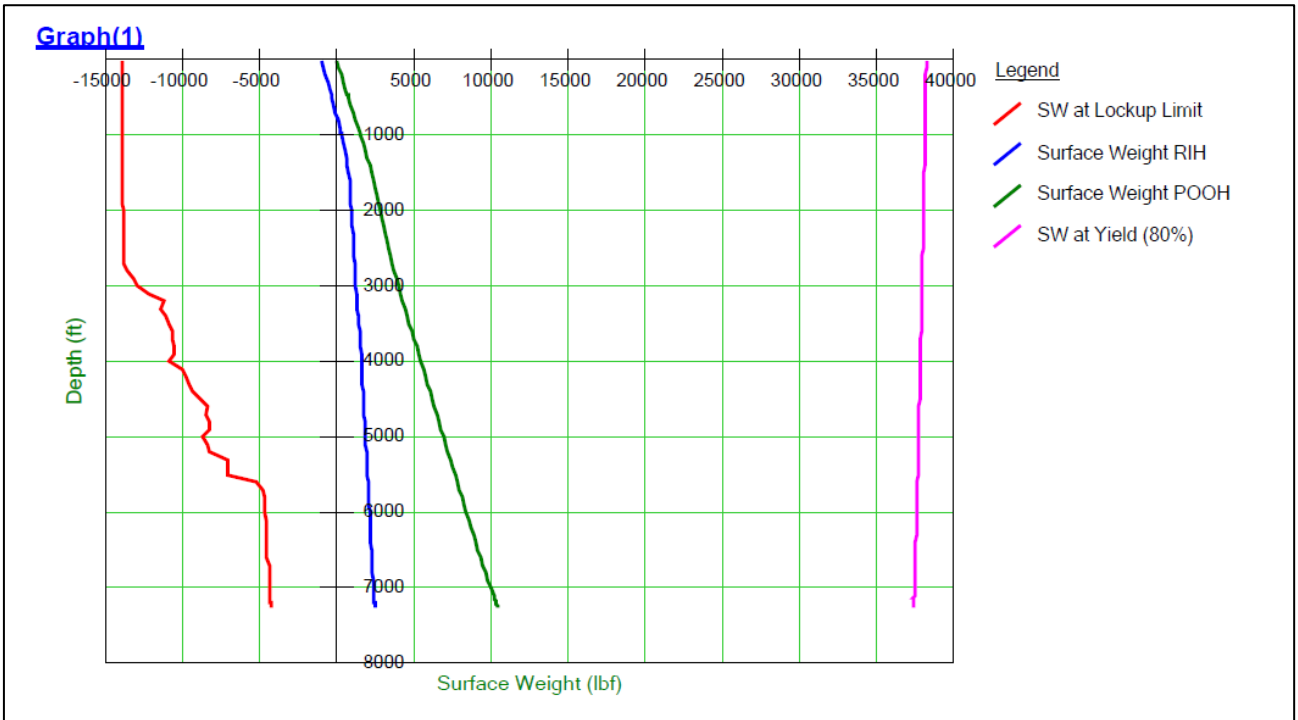

DIMENSION BID

DIMENSION BID COILED TUBING SERVICES



DULANG C-4 S

CEMENT PACKER

Friction Factor 0.3 (Default Value)

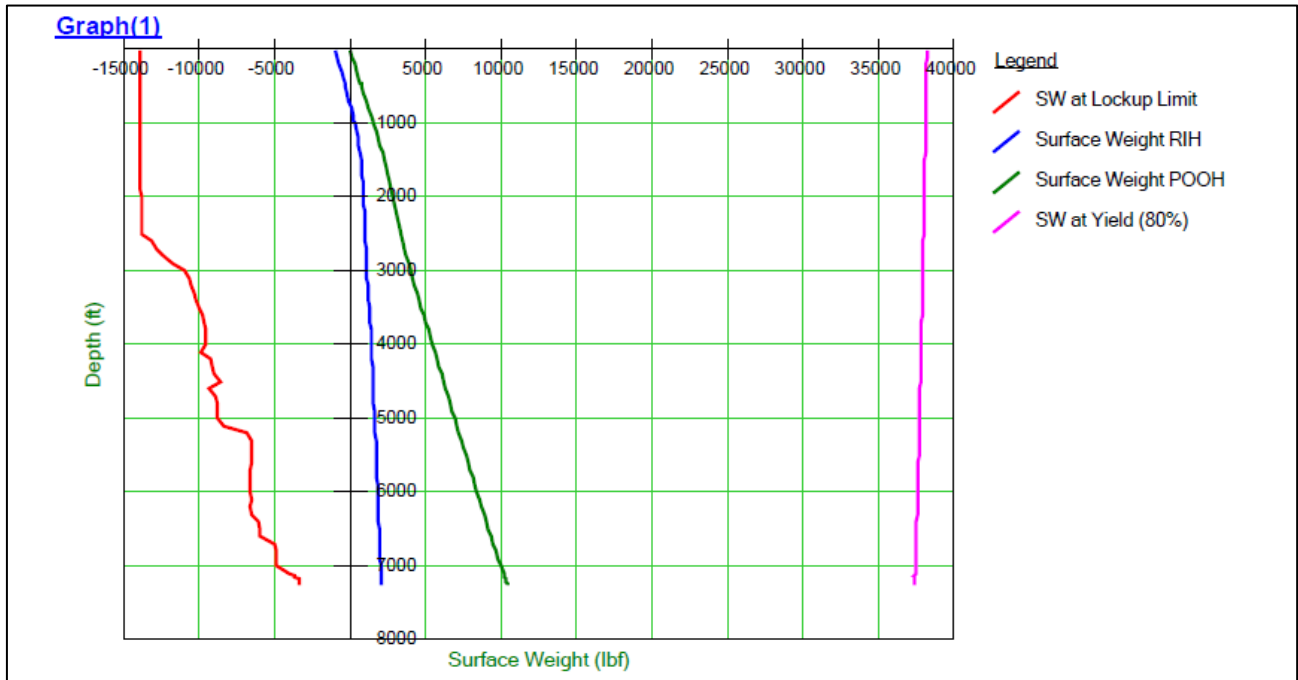

Friction Factor 0.35

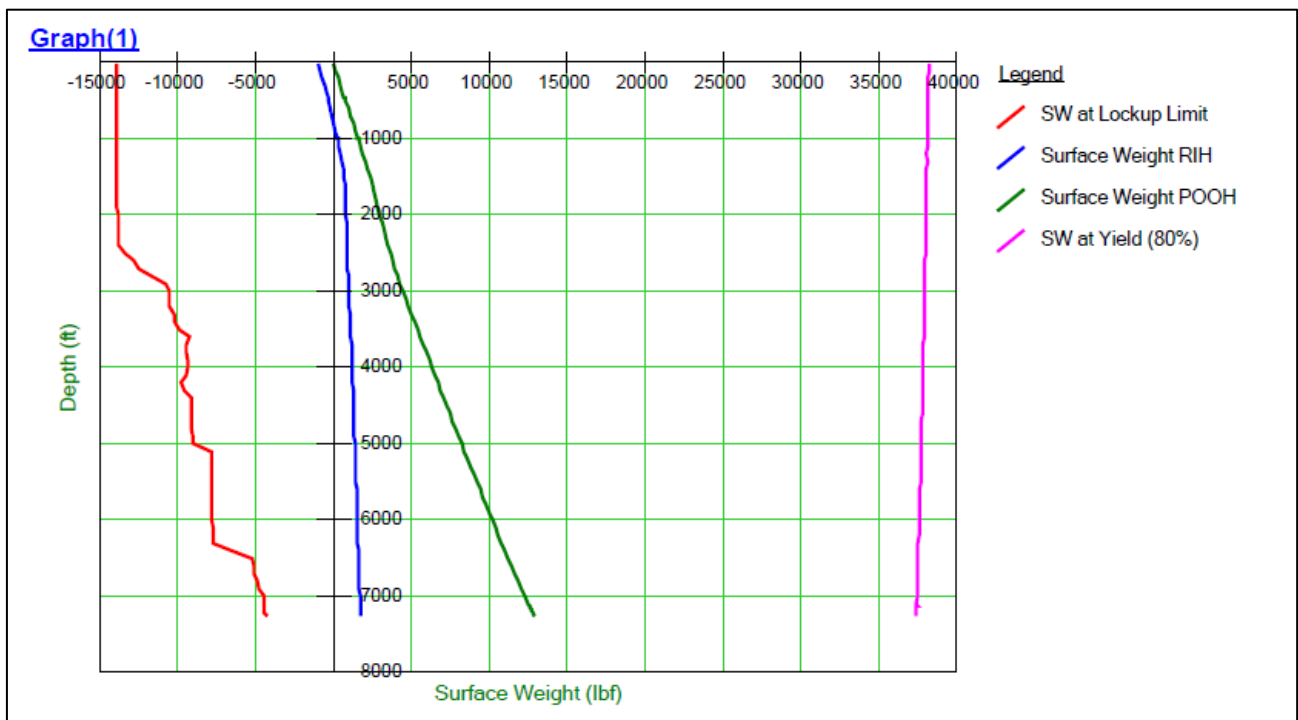

Friction Factor 0.4

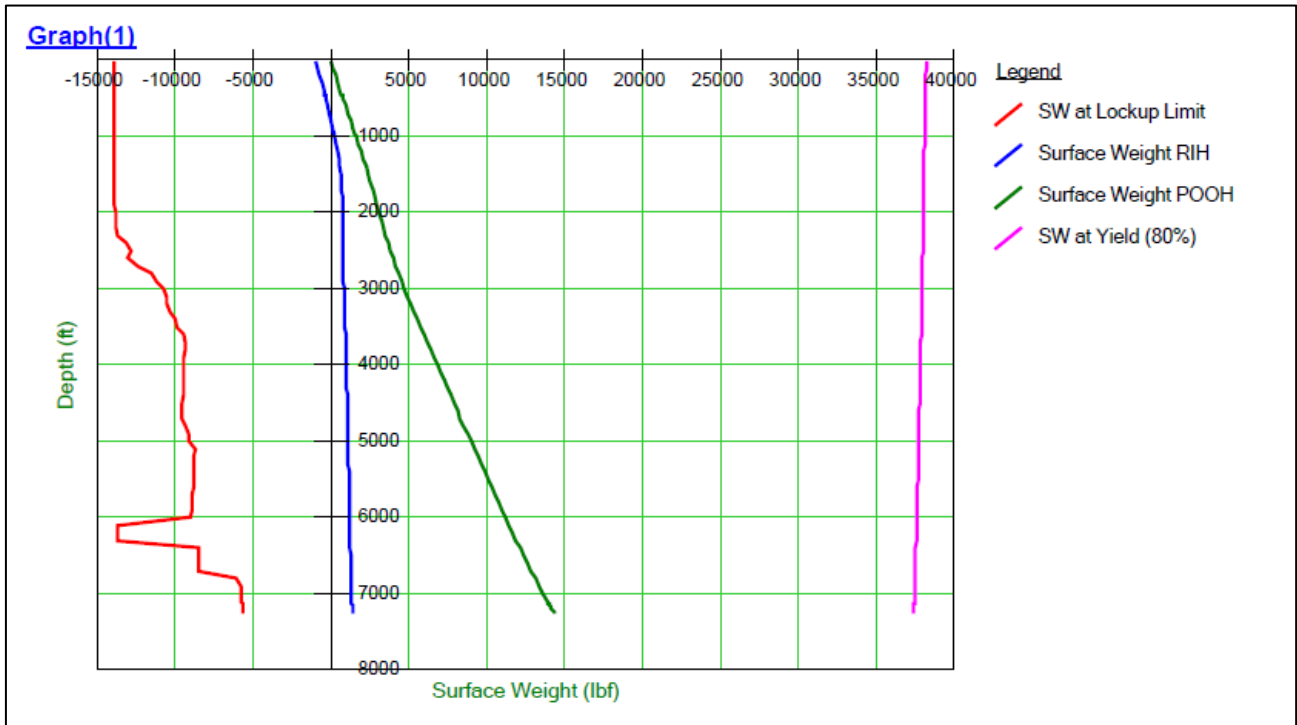

Friction Factor 0.5

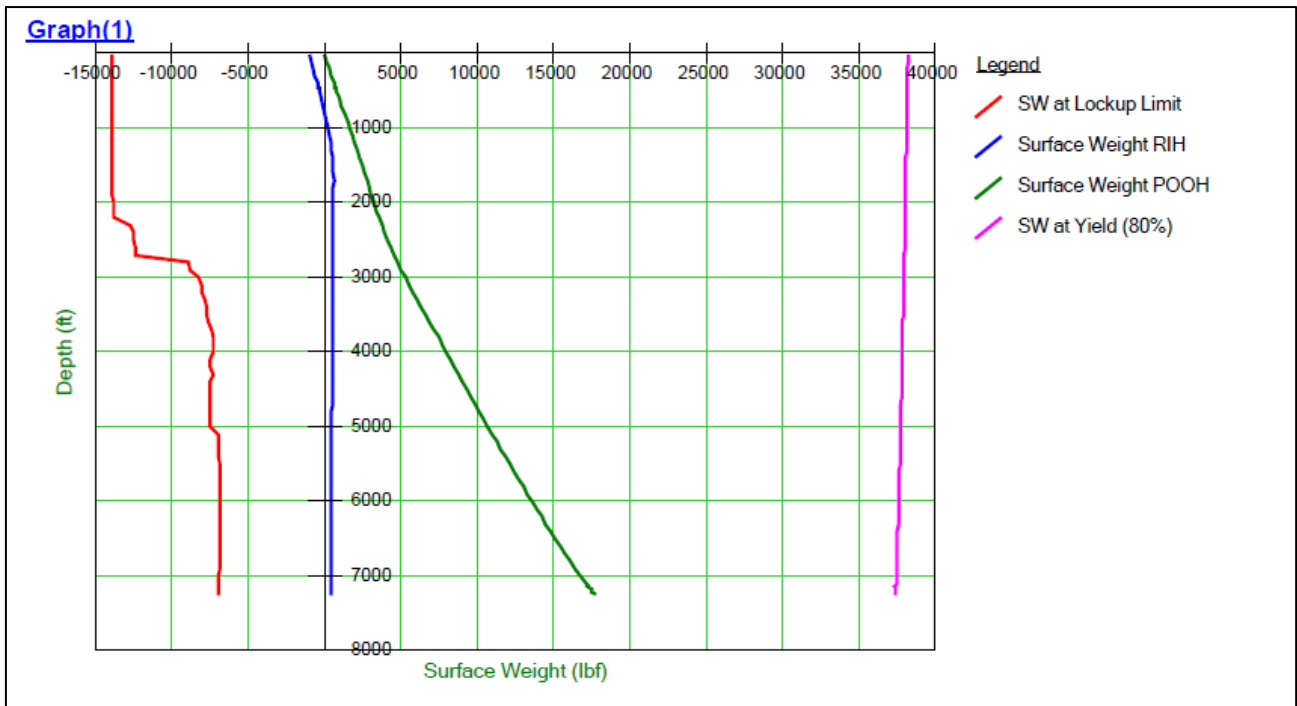

DIMENSION BID	DIMENSION BID COILED TUBING SERVICES		
	DULANG C-4 S	CEMENT PACKER	

APPENDIX IV – EMERGENCY PROCEDURE

EMERGENCY BOP OPERATIONS

In the event of an emergency arising and the well having to be secured, the following steps should be taken:

1. Stop CT movement, close the Slip and Pipe rams and slack off string weight to ensure slips are holding. If time permits, review all options with the client representative. (Ensure that rams with guides are activated first to avoid damaging the CT).

Note: The decision to proceed past the above step should normally be made after consultation with the client representative unless there is an immediate and serious danger to personnel and/or equipment and the client representative is not immediately available to be involved in the decision.

2. Stop pumping.
3. Close the upper Shear Seal rams to cut the CT.
4. Set up to circulate well to kill fluid through the CT remaining in the well.
5. Make arrangements necessary to fish the CT from the BOP.

Note: When actuating any ram in the BOP system, the corresponding manual lock should be closed behind it to prevent accidental release in the event of total loss of hydraulic power. The force required to close the rams manually against pressure cannot be supplied by turning in the locks. Use of a pipe wrench, cheater bars or snipes will damage the internal workings of the ram actuators. Some form of hydraulic power is required to operate the actuators. This pressure can be supplied via a hand pump or a hydraulic pump from any other piece of equipment on location, including a fluid pumper.

Actuating the BOP System Hydraulic Controls

1. Remove locks on control panel
2. Move the control lever to the desired position.
3. Push the BOP activate button supplying pressure to the circuit.
4. Observe the pressure drop in the hydraulic circuit and subsequent pressuring back up to system pressure as ram opens or closes completely.
5. Observe the ram indicator pins to verify the operation of the ram.
6. Close in the manual locks if required. (Flag system to indicate position of rams.)

The connections below the CT BOP must be all flanged. Should one of these connections start leaking, the following steps should be taken in consultation with the client representative:

1. Call local alert and ensure all personnel are removed from the wellhead area.
2. Notify the client representative of the problem and determine the best method to make the area safe.
3. If the leak is minor, it may be possible to continue to pull the CT to surface. Assess the scenario and consider all the risks associated then proceed to pull the CT to surface. Once at surface, close available valves below the leak point.
4. If the leak is more severe, initiate a well kill through the well kill line and continue to pull the CT to surface.
5. If the leak is catastrophic, run the CT to HUD; pick up sufficient so that after the CT is cut at surface by CT BOP shear; the top of the CT falls below the X-mass Tree. Once the end of the CT is off bottom, proceed to cut the cut the CT with the shear RAM then close the available valves below the leak point. A well kill operation can be started through the kill line if requested by the client representative.

Prepared By: Muhammad hafiz	Reviewed By: Kung Yee Han	Date: 20/3/2024	Rev. Rev3	Controlled Document DB-CT-MHS-230238	Pg. 52
--------------------------------	------------------------------	--------------------	--------------	---	-----------

DIMENSION BID	DIMENSION BID COILED TUBING SERVICES		
	DULANG C-4 S	CEMENT PACKER	

LEAK IN CT AT SURFACE

In the event of a leak in the CT occurring at surface, the following steps should be taken:

1. Call local alert and ensure all personnel are removed from the operational area. In particular make sure all personnel remain clear of the area between the Injector Head and the CT reel.
2. If the leak is small or a pinhole leak, POOH and position the leak on the lower part of the CT reel as soon as possible. Be careful when area of leak is bent onto the reel as failure may occur. Make arrangements to have a water hose present to wash away any fluid from the reel which may be hazardous. Make arrangements to start pumping water through the CT reel. Depressurize reel as much as conditions allow without exceeding collapse limitations of CT.
3. Notify client representative of problem and determine best method to make area safe. If leak is minor and water can be displaced to leak, continue to POOH and change reel.
4. If leak is considered to be too serious to displace to water and POOH, or serious and uncontrolled leakage of hydrocarbon or hazardous materials prevents this, (i.e. check valves not holding, lost BHA, parted CT) set the CT slips and pipe rams. Activate the upper Shear Seal rams on either the triple or quad BOP and manually lock in place.
5. Depressurize the CT reel and flush through the reel. If hydrocarbons are present in the reel, displace the reel with water and empty the contents to specified safe disposal area.

LEAK IN CT BELOW SURFACE

If a leak occurs in the CT below the Stuffing Box during down hole operations (usually indicated by a drop in pump pressure or loss of string weight), suspend CT operations and alert the client representative.

Note: If indications are that the BHA has been lost in hole then revert to section 0.

1. Once the client representative has been alerted, clear all personnel from the immediate area of the CT around the Injector Head and between the Injector Head and the CT reel.
2. Displace the CT to water and commence to POOH at not more than 20 ft per minute (5 meters/min). Ensure at all times that all personnel are clear of the immediate area as the possibility exists to pull the CT out of the Stuffing Box. Continue pumping water at a slow rate through the CT.
3. When the leak in the CT appears above the Stuffing Box, stop the injector and hold the leaking section of CT between the chains and the Stuffing Box.
4. Inspect leak. If leak is minor continue to POOH.
5. If leak is major, or CT is actually severed or well bore fluids are escaping through the CT, continue as per Section 09.2.

Prepared By: Muhammad hafiz	Reviewed By: Kung Yee Han	Date: 20/3/2024	Rev. Rev3	Controlled Document DB-CT-MHS-230238	Pg. 53
--------------------------------	------------------------------	--------------------	--------------	---	-----------

DIMENSION BID	DIMENSION BID COILED TUBING SERVICES		
	DULANG C-4 S	CEMENT PACKER	

LEAK IN SURFACE PRESSURE CONTROL EQUIPMENT

Stuffing Box

1. **Stop** CT movement and close both sets of pipe rams to seal CT annulus. Set manual lock.
2. On semi-submersible operations this will be a set of pipe rams and pipe/slip rams.
3. Notify Client representative.
4. Ensure the injector is in neutral and that the brake is engaged.
5. Bleed off pressure above pipe rams
6. Set reel brake. On Semi-Submersible jobs the CT should be clamped at the level wind and CT run out of hole until enough slack between the injector and reel is obtained to cope with the heave from the rig, prior to setting reel brake.
7. Bleed off closing pressure on Stuffing Box. Open side doors and apply pressure to retract piston. Replace packer elements and then re-apply pressure to Stuffing Box. Close side doors.

Note: 3" side door Stuffing Boxes first bleed off closing pressure. Remove hoses from pack and retract piston and connect to open and close on side door. Open door and replace packer element. Close door, bleed off pressure and connect to pack and retract piston.

8. Slowly open both equalizing valve on pipe rams and check that stripper is holding pressure.
9. If stripper is holding pressure, undo manual locks and open pipe rams or pipe slip rams. When using pipe/slip rams the depth that they were set on the CT must be recorded. Release reel brake and continue operations.

Surface Leaks Other Than Stuffing Box

1. If leak is minor and a relatively short length of CT is in the hole and the Shear Seal safety head is **below the leak**:
2. Call local alert and notify the client representative.
3. Clear all non-essential personnel away from the area
4. Continue POOH and monitor situation closely
5. Hook up kill line to BOP and pump water slowly down annulus.

Note: Avoid collapse situation

1. Close swab valve and Shear Seal once CT is in riser and repair leak
2. Perform reinstatement test on surface equipment after leak has been repaired
3. If CT is in the well to a considerable depth and leak is considered serious:
4. Call local alert and notify Client representative.
5. Ensure all non-essential personnel are removed from the area.
6. Ensure that CT is sufficiently off bottom so that when the Shear Seal safety head is activated the pipe will drop below the Xmas tree manual master valve. If the CT is stuck down hole, pull to 80% of operating limit before activating Shear Seal BOP, thus allowing the CT to drop below the Xmas tree manual master valve. If the CT is attached to a fish, packer etc pull to 80% of operating limit (if possible) or maximum weight possible before activating Shear Seal BOP, thus allowing the CT to drop below the Xmas tree manual master valve. **If at all possible**, the decision to cut the CT and activate the system will be taken by the Client representative in charge of the operation. This may not always be possible. If the situation is extremely dangerous and requires a fast decision, the Supervisor in charge will take this decision.

Prepared By: Muhammad hafiz	Reviewed By: Kung Yee Han	Date: 20/3/2024	Rev. Rev3	Controlled Document DB-CT-MHS-230238	Pg. 54
--------------------------------	------------------------------	--------------------	--------------	---	-----------

7. Close the Shear Seal rams in the safety head to cut the pipe and allow it to drop. (If the safety head has separate shear and blind rams, close the shear rams to cut the pipe, pull up the CT and close the blind rams).
8. Close the swab valve on the Xmas tree.
9. Close the master valve on the Xmas tree
10. Repair leak and pressure test riser.
11. Plan for fishing operations.

Rotating Joint Leak

Eliminate the potential for reel movement by securing the reel with turnbuckles and set reel brake. On Semi-Submersible jobs the CT should be clamped at the level wind and CT run out of hole until enough slack between the injector and reel is obtained to cope with the heave from the rig. Close the reel isolation valve inside the reel and repair or replace the rotating joint as required. Re-test and resume operations.

CT RUNS AWAY INTO WELL

If the inside chain tension system on the Injector Head should fail for any reason, and CT is pulled into the well under its own weight with no control, the procedure should be as per the following:

1. Call a local alert.
2. Attempt to speed the injector up to match the speed of the descending CT.
3. Increase inside chain tension to increase friction on CT.
4. Increase stripper pressure to exert more friction on CT.
5. If these actions fail to make any difference, reduce injector hydraulic pressure to zero.
6. In the event that there is insufficient CT on the reel to reach bottom close CT slips. This action may damage or break the CT. This is the preferred option to using the pipe rams as these will become damaged and a primary well control system will be lost.
7. If the CT is not too far off bottom it may be practical to let it fall to bottom then investigate the causes and repair. This can only be done if there is sufficient CT on the reel to reach bottom.

Note: CT may helix when hitting bottom making it difficult to pull into tail pipe.

8. Once CT has been controlled, examine Injector Head for damage including chains and POOH.
9. The CT run away may be caused by the injector becoming overloaded with the weight of the CT and fluid in the CT. This situation should not occur if proper pre job planning is done. Correct selection of Injector Head or ensuring CT is full of Nitrogen would prevent this situation from occurring.
10. If a runaway situation occurs, reduce the injector hydraulic pressure to zero. This may cause the safety brake in the motors to actuate and counter balance valves to close, stopping the injector.
11. Under certain circumstances if the runaway CT is at a speed above the critical speed, the back pressure created by the circulating hydraulic fluid may prevent the injector motor brakes from actuating. If this situation occurs, select the pull mode for the injector and increase system hydraulic pressure until the CT comes to a standstill.

DIMENSION BID	DIMENSION BID COILED TUBING SERVICES		
	DULANG C-4 S	CEMENT PACKER	

CT IS PULLED OUT OF STUFFING BOX

This situation is most likely to occur when the CT is being pulled into the riser section. If the BHA is lost including the End Connector there will be no external upset to prevent the CT from passing through the Stuffing Box. If this situation occurs, stop injector before CT passes through the chains and shut in Shear Seal rams on upper BOP's.

If it is thought that the BHA may be lost while down hole, stop the CT at 300ft from surface. Slowly close in the swab valve counting the number of turns. If the CT is still deemed to be across the wellhead, POOH the CT no more than the distance between the top of the wellhead and the top of the CT BOP's. Repeat this step until the swab valve can be fully shut. Once the swab valve is shut, bleed off the pressure in riser.

CT COLLAPSED AT SURFACE

Collapsed CT at surface will be obvious by escape of well bore fluids from the Stuffing Box, as the strippers will no longer seal round the deformed pipe. In addition to this the collapsed pipe will not allow the Injector Head to grip the CT due to its change in shape. Usually collapsed CT will not pull through the bottom brass bushings on the Stuffing Box.

1. If POOH, immediately run CT back in well a sufficient distance to make sure round pipe is in contact with the Stuffing Box.
2. Call alert and notify client representative.
3. Ensure that all non-essential personnel are cleared from the immediate area.
4. Immediately reduce well head pressure by all safe means possible; either flow well through choke at a higher rate or stop annular fluid injection if reverse circulating.
5. Increase CT internal pressure by circulating.
6. Once pressure conditions inside and outside the CT have been optimized, a decision can be taken on how to proceed. If it is not possible to position un-collapsed pipe across the stripper rubbers, i.e., well contents are escaping from stripper rubbers:
7. Call alert and notify client representative.
8. Close pipe rams in an effort to reduce flow of fluid/gas around CT.

Note: If it is not possible to control the well, the slips will have to be set, and the CT cut using the Shear Seal rams.

9. Arrange for clamps to be fitted to CT above Injector Head.
10. Remove all non-essential personnel from immediate area
11. Under authority from client representative, kill well.
12. Release pressure from Stuffing Box and remove bushings.
13. Open pipe rams.
14. Attempt to pull CT from the well using the Injector Head.
15. Cut CT at the gooseneck and use the rig or a crane to pull the CT through the injector. Re-clamp the CT above the Injector Head and cut off in thirty-foot sections (or as appropriate to the crane or rig)
16. Continue pulling and cutting CT until the CT pulled to surface can be pulled by the Injector Head.
17. Once CT in good condition (i.e. not collapsed) is at surface, set CT slips and pipe rams and make up roll-on connector to CT on reel.
18. Continue POOH.

If the leak is too serious and cannot be controlled and well fluids are escaping, continue as per Section 9.2.

CT BREAKS AT SURFACE

If CT breaks at surface into two separate sections:

Prepared By: Muhammad hafiz	Reviewed By: Kung Yee Han	Date: 20/3/2024	Rev. Rev3	Controlled Document DB-CT-MHS-230238	Pg. 56
--------------------------------	------------------------------	--------------------	--------------	---	-----------

1. Stop the injector and set the slips.
2. Stop pumping operations.
3. Call alert and notify client representative. Ensure all non-essential personnel are cleared from the area and that the area is secure.
4. Secure CT reel.
5. If the reel capacity is insufficient to hold all of the CT remaining in the well due to uneven spooling resulting from the CT failure, it may be necessary to obtain another reel with sufficient capacity to hold the CT remaining in the well.
6. After consulting with client representative, remove damaged section of CT and insert in line roll-on connector and continue to POOH.
7. If this course of action is considered inappropriate or dangerous due to well conditions or condition of CT still in the well, continue as per Section 0.

BUCKLED TUBING

Should the CT hit an obstruction down hole while RIH with the thrust pressure set too high or running speed too fast, the CT will buckle in a 'Z' shape (plastically hinged).

CT being run inside CT and through small ID BOP's/lubricators will normally buckle between the Stuffing Box and the chains.

CT being run through casing or open hole will normally break below the BOP, usually somewhere around the largest ID.

- The CT will generally buckle several times.
- This type of failure is a little more difficult to detect.

If the CT is being run into casing and a large amount of weight is lost suddenly, there is a very good possibility that the CT is buckled somewhere down hole. Indications of this could be:

- An increase in pump pressure as fluid or gas is now being pushed through an additional restriction created by a hinge.
- A decrease in pump pressure as the CT may have broken removing a restriction such as a BHA.
- A loss of string weight due to the CT breaking and falling off.
- An increase in string weight while pulling out of the hole as the buckled portion of CT creates additional drag or needs to be straightened to get through a restricted ID.

In the event CT buckling is suspected, the CT movement should be stopped and the pump pressure kept within operating limits allowing the situation to be analyzed and determine the correct action to be taken for existing conditions.

If there is an increase in pump pressure or an increase in string weight:

1. Stop the pumps and pick up slowly.
2. POOH slowly (10 to 20 feet per minute) watching the weight indicator carefully.
3. If the CT is buckled close to surface, the buckled CT will pull into the bottom of the Stuffing Box and stop.
4. Close and lock the slip and pipe rams.
5. If the ram indicators show that the rams are not completely closed, there may be more than one piece of CT inside the BOP. In this event, open the rams and try to put undamaged CT across the pipe and slip rams.
6. Make arrangements to kill the well and retrieve the remaining CT from the well.

DIMENSION BID	DIMENSION BID COILED TUBING SERVICES		
	DULANG C-4 S	CEMENT PACKER	

7. If the buckled CT is down hole and cannot be pulled free, consult the client representative as he may want the CT left at TD prior to being hung off in the slip and CT rams.
8. Arrangements should be made to run CT cutter on wireline to retrieve the CT above stuck point.

If there is a decrease in pump pressure or a loss of string weight:

1. It must be assumed that the CT has parted somewhere down hole.
2. Calculate from the remaining string weight approximately how much CT is left in the well.
3. Stop the pumps and POOH slowly.
4. Should the CT come out of the Stuffing Box, the blind rams should also be closed in.

If the CT is buckled above the Stuffing Box, the following steps should be taken:

1. Stop the injector as quickly as possible.
2. Close the slip and pipe rams and manually lock them.
3. If the down hole check valves are holding, bleed the pressure in the CT down to zero and monitor for 15 minutes for pressure build up.
4. Consider at this stage whether to kill the well.
5. Use a hacksaw to start the cut until you are sure there is no trapped pressure in the CT.
6. Cut the CT
7. Remove as much of the buckled CT as possible leaving any undamaged CT showing above the Stuffing Box intact so that it may be rejoined later.
8. Bleed the pressure from above the CT rams and undo the connection below the injector.
9. Slowly raise the injector until it is clear of the damaged CT.
10. Cut away any damaged CT, dress the CT and install an inline connector.
11. Run some fresh CT down through the injector until it is just out of the Stuffing Box.
12. Lower the injector until immediately over the pipe sticking out of the BOP.
13. Attach the pipe to the inline connection attached to the pipe sticking up out of BOP.
14. Pump off the inside chain tension and rotate the chains slowly in the OOH direction, while lowering the injector until the connection below the injector can be fastened.
15. Pump up the inside chain tension and pull weight equal to the weight of the CT suspended below the slips plus 2,000 lbf for friction or CERBERUS prediction, whichever is greatest.
16. Equalize the pressure across the CT rams.
17. Unlock the pipe and slip rams.
18. Open the slip and pipe rams and POOH.
19. If the down hole check valves do not hold then the CT will have to be cut.

CT STUCK IN HOLE PROCEDURES

There are various scenarios by which CT can be deemed as a stuck in hole situation. The following procedures are to be used as generic guidelines prior to the compilation of a signed off chemical cutting program applicable to the current situation.

In the event of being stuck in hole, several factors would have to be taken into consideration, the first of which would be whether the CT is stuck in hole on a platform, or a semi-submersible, as the procedures to be followed may vary greatly between the two options.

Other factors to be considered are:

Prepared By: Muhammad hafiz	Reviewed By: Kung Yee Han	Date: 20/3/2024	Rev. Rev3	Controlled Document DB-CT-MHS-230238	Pg. 58
--------------------------------	------------------------------	--------------------	--------------	---	-----------

DIMENSION BID	DIMENSION BID COILED TUBING SERVICES		
	DULANG C-4 S	CEMENT PACKER	

- Type of well, i.e., flowing oil or gas well, water injector etc.
- The type of BHA being used, i.e., perforating guns, milling assembly, plug etc.
- The type of operation being carried out when the CT became stuck.

In all of the above cases, the CT would be defined as being “stuck” when the pipe cannot be retrieved from the well bore without the pipe exceeding its 80% minimum yield rating, or without exceeding 80% stress of the weak link release rating. The lower of these two factors should always be used when attempting large pulls.

Regardless of the specifics involved, the following procedures should be adopted:

1. Inform the client representative of the situation.
2. Inform the Onshore Engineer.
3. From the information available, and taking into account the well conditions, try to determine the reason for the pipe/BHA being stuck.
4. Attempt to pull free by applying a steady pull to a maximum of 80% of the CT yield. If in doubt as to what this figure is, consult Engineering Department before proceeding.
5. When applying the maximum pull, hold the maximum value for a minimum of 10 minutes and observe the trend (if any) on the weight indicator and chart. Measure the amount of pipe extension that is required when this pull is applied. The figure can be used to determine where the CT is stuck. As a rule of thumb, the depth that the pipe is held at will be the extension of the CT (in feet) when pulled to 80% of yield divided by 0.002. This can be determined using CERBERUS.

The following are options that may be appropriate depending on the particular circumstances:

1. If possible, flow the well, or increase well flow in an effort to remove debris in the well bore that may be holding the CT/BHA. Maintain maximum circulation through the CT at the same time. This is particularly relevant if well cleanout or drilling operations have been performed.
2. Circulate acid across the BHA in an attempt to remove any acid soluble material that may be holding the CT.
3. Pump fluid down the backside of the CT to the formation in an attempt to dislodge debris from around the BHA. Potential CT collapse must be considered if engineering this scenario.
4. Displace CT contents to a lighter fluid (base oil) or gas (Nitrogen) to increase buoyancy and allow greater end force to be applied at BHA.
5. Underbalance the well in the case of differentially stuck CT.
6. Cool the well if the CT is helically stuck in corkscrewed Production Tubing.
7. Pump down the CT / completion annulus to try and move the source of hold-up.
8. Displace slugs of Nitrogen with water to create a surge effect at the BHA.
9. Pump friction reducer, IM Lube in seawater at 2-3% by volume, down the CT and into the well. Ideally, one well volume will be pumped.
10. After consultation with the client representative and the on-call Engineer, activate the emergency disconnect mechanism in the BHA to allow the CT to be released. The release mechanism should only be implemented after all avenues have been explored.
11. When attempting maximum pull, do not work the CT violently across the gooseneck by frequent intervals.
12. The number of cycles across the gooseneck must be logged, and if in doubt of the CT fatigue condition, the Engineer must be consulted and the cycles entered into the CERBERUS FATIGUE program, to determine the number of cycles left available.

After consultation with the client representative, kill the well and commence preparations for External/Internal cutting operations.

Prepared By: Muhammad hafiz	Reviewed By: Kung Yee Han	Date: 20/3/2024	Rev. Rev3	Controlled Document DB-CT-MHS-230238	Pg. 59
--------------------------------	------------------------------	--------------------	--------------	---	-----------

STUCK CT COIL RECOVERY PROCESS

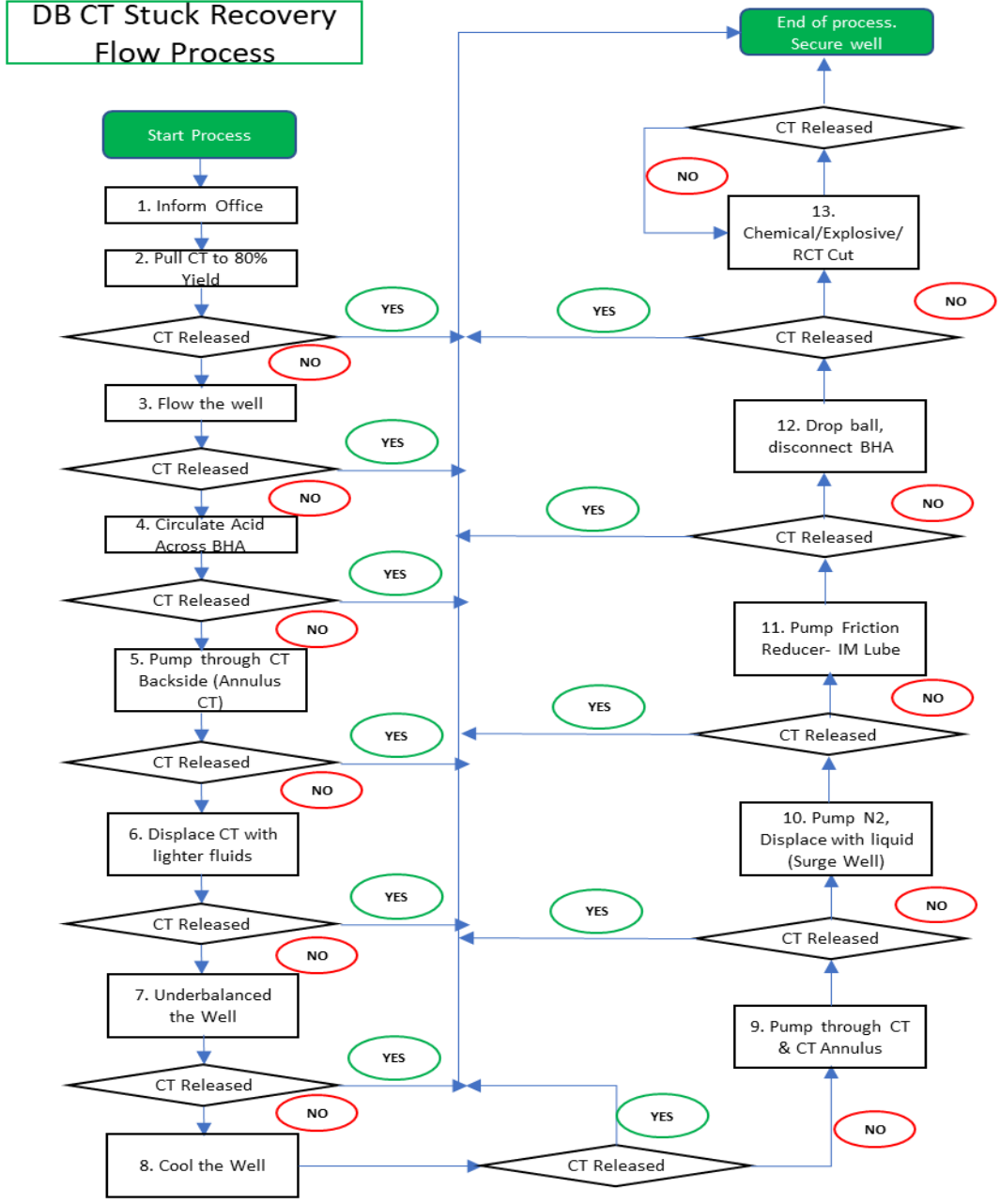

Precautionary Steps to avoid Stuck while Cleanout in Dual string Completion:

- 1) To monitor pressure trending all the times during operation and record for any abnormalities. If there is continue pressure increasing trend during cleanout, proceed to pick up coil to the previous pull test depth and perform flow rate test.
- 2) In the event of coil entangle on the Long string, proceed to pick up coil and simulate pumping lost prime scenario to create vibration and tip of coil wobble to release from entanglement.

APPENDIX V – DOWNHOLE TOOL SPECS

SpinCAT



STONEAGE SPINCAT™ SC-168 †SHARE

The StoneAge SpinCat™ SC-168 can be used at operating pressures of 1000 to 5000 psi and flow rates of .7 to 1.33 bpm (30 to 56 gpm). It has a 1" AMMT inlet thread.

Tool Family	StoneAge SpinCat™	
Tool Model	SC-168	
Pressure Range	1-5k psi	70-340 bar
Flow Range	0.7-1.33 bpm	30-56 gpm
Flow Rating	2.3 Cv	
Rotation Speed	150-200 rpm	
Inlet Connection	1" AMMT	
PSI Loss (@ 1 bpm)	330 psi	23 bar
Tension (pull)	Safe load to 8500 lbs	3856 kg
Compression (set down)	Safe load to 12000 lbs	5443 kg
Outside Diameter	1.68 in.	4.3 cm
Overall Length	9.8 in.	25 cm
Weight	4.6 lbs	2 kg
Maximum Temperature	390° F	200° C



STONEAGE SPINCAT™ SC-212 †SHARE

The StoneAge SpinCat™ SC-212 can be used at operating pressures of 1000 to 5000 psi and flow rates of 0.8 to 2 bpm (32 to 80 gpm). It has a 1 1/2" AMMT inlet thread.

Tool Family	StoneAge SpinCat™	
Tool Model	SC-212	
Pressure Range	1-5k psi	70-340 bar
Flow Range	0.8-2.0 bpm	32-80 gpm
Flow Rating	4.6 Cv	
Rotation Speed	150-200 rpm	
Inlet Connection	1-1/2" AMMT	
PSI Loss (@ 1 bpm)	83 psi	6 bar
Tension (pull)	Safe load to 15000 lbs	6804 kg
Compression (set down)	Safe load to 21000 lbs	9525 kg
Outside Diameter	2.12 in.	5.4 cm
Overall Length	12.3 in.	31.2 cm
Weight	8.9 lbs	4 kg
Maximum Temperature	390° F	200° C

DIMENSION BID	DIMENSION BID COILED TUBING SERVICES		
	DULANG C-4 S	CEMENT PACKER	

WEATHERFORD CT PACKER

CT (Coiled Tubing) Packer

Weatherford's CT packer is ideal for use on coiled tubing (CT) in straight-hole or deviated well conditions. The packer is set and released by reciprocation of the CT, allowing the packer to be set and un-set multiple times in a single run.

The single piece mandrel design increases the durability of the packer, allowing it to be used in applications with high tailpipe loads and minimizes potential leak paths through the tool.

Applications

- Ideal for treating and testing applications.
- Can also be used for velocity string hang-offs and as the lower packer in patch applications.

Features, Advantages, and Benefits

- Set and release by reciprocating motion facilitates use on CT.
- New drag spring design offers improved drag and stronger springs for reliable setting in deep wells, minimizing misruns.
- High performance packing elements provide high differential pressure ratings
- Sealed J-Slot housing prevents debris from hampering setting and releasing, minimizing misruns.
- Increased tensile strength handles heavier tail-pipe loads for heavy velocity string hang-offs.
- Large-bore mandrels provide larger flow area for increased production.
- Double J-Slot requires two reciprocations before setting, preventing premature setting during weight checks and when entering liner tops, minimizing misruns.



APPENDIX VI – CIRCA SIMULATION

Cleanout until SSD#2 Area (Low reservoir pressure LD3 – 900 psi)

Flow Summary

SUMMARY OF FLOW RESULTS

Produced Fluids
Pressure known at:
Production Mode:
Fluid Composition:

Perforations
No Production
Oil and Gas

Circulated Fluids
Fluid Composition:

Nitrified Water

Liquid:
Solids:
Gas:
Circulation Point:
HHP Required :

0.30 bbl/min
0.00 bbl/min
400.0 scf/min
2215.00 m
8.73 KW

COMPLETION:

Wellhead Pressure.....
Hydrostatic pressure loss.....
Friction pressure loss.....
Kinetic pressure loss.....
Restriction pressure loss.....
Equivalent Circulation Density[ECD]...

143.6 psi g
481.0 psi
298.7 psi
-3.7 psi
0.4 psi
3.39 lb/gal (US)

Perforation Pressure.....
Hydrostatic pressure loss.....
Friction pressure loss.....
Kinetic pressure loss.....
Restriction pressure loss.....

900.0 psi g
208.4 psi
1.3 psi
-0.1 psi
0.1 psi

Bottom Hole Pressure.....

1109.7 psi g

FROM CIRCULATION POINT TO WELLHEAD:

Liquid transit time.....
Gas transit time.....
Annular volume.....

14 min
8 min
26.2 bbl

Volume below circulation point.....	57.5 bbl
Total liquid volume.....	63.0 bbl
Total gas volume.....	20.8 bbl
(Surface equivalent).....	3529.6 scf

WORKSTRING:

Liquid:	0.3000 bbl/min
Gas:	400 scf/min
Pressure at reel rotating joint.....	1577.3 psi g
Friction pressure loss on reel.....	429.5 psi
Hydrostatic pressure loss on reel.....	0.1 psi
Pressure inside WS at Gooseneck.....	1147.7 psi g
Hydrostatic pressure loss.....	-738.5 psi
Friction pressure loss.....	720.0 psi
Equivalent Circulation Density[ECD]...	0.09 lb/gal (US)
BHA total pressure loss	261.4 psi
BHA Hydrostatic loss	-0.6 psi
BHA Friction loss	1.7 psi
BHA Kinetic loss	0.9 psi
Nozzle	259.5 psi
Circulation Point pressure	904.8 psi g

FROM REEL ROTATING JOINT TO CIRCULATION POINT:

Liquid transit time.....	23 min
Gas transit time.....	17 min
Displacement Volume.....	15.9 bbl
Internal Volume.....	22.0 bbl
Internal liquid volume.....	6.9 bbl
Internal gas volume.....	15.1 bbl
(Surface equivalent).....	6967.8 scf
Length of Workstring on reel.....	2199.88 m

Ctran Summary

SUMMARY OF HOLE CLEANING RESULTS

Initial Condition:	
% of fill interval occupied by solids before cleanout ...	50.0 %
Top of fill	1985.01 m
Deepest Circulation point	2215.01 m
Bottom of fill	2215.01 m
Initial Volume of Solids.....	2.2 bbl
Initial Mass of Solids.....	1119.1 lb
Solids type:	Mud Residue/Formation Fines
Fluid Description:	Nitrified Water
Penetration Hole Cleaning Mode:	
Penetration rate.....	5.0 ft/min
Penetration time.....	2.52 hr
Solids volume in the well after penetration	2.2 bbl
Solids mass in the well after penetration	1119.1 lb
Circulation Hole Cleaning Mode:	
Hole circulation time	5.00 hr
Solids volume in the well after circulation.....	0.7 bbl
Solids mass in the well after circulation.....	382.2 lb
Wiper Trip Hole Cleaning Mode:	
Wiper Trip Scheme:	User Specified rate, Tornado not
Wiper trip time	3.17 hr
Solids volume in the well after wiper trip	0.0 bbl
Solids mass in the well after wiper trip	0.0 lb
Volume of Fluids Pumped During Penetration, Circulation & Wiper Trip:	
Gas volume	256409.2 scf
Liquid Volume	192.3 bbl
Penetration, Circulation & Wiper Trip time	10.68 hr

Circulation results at point of Maximum Solids Head:

Project: Dulang C-4S	Field-Well: Dulang Charlie	
<hr/>		
BHA Depth		2215.01 m
Elapsed time		1.8512 hr
Wellhead Pressure		196.4 psi g
Additional Head created by Solids.....		27.9 psi
Maximum % solids circulated up hole was 1.3%.		
This occurred at a measured depth of		739.75 m
after the transient had run for		0.0 hr

DIMENSION BID

DIMENSION BID COILED TUBING SERVICES



DULANG C-4 S

CEMENT PACKER

Flow State

Measured Depth[Flow] <i>m</i>	Temperature <i>Deg. F</i>	Completion Pressure <i>psi g</i>	Workstring Pressure <i>psi g</i>	Concentric Pressure <i>psi g</i>	Completion Liquid Velocity <i>in/s</i>	Workstring Liquid Velocity <i>in/s</i>	Concentric Liquid Velocity <i>in/s</i>
0.0	80.0	143.6	1147.7	0.0	104	122	0
28.4	82.7	160.4	1157.1	0.0	102	122	0
57.3	85.4	176.8	1166.8	0.0	100	122	0
86.3	88.2	192.5	1176.1	0.0	98	122	0
115.2	90.9	202.8	1185.3	0.0	139	122	0
144.2	93.6	213.1	1194.5	0.0	161	122	0
153.6	94.5	216.5	1197.5	0.0	133	122	0
182.6	97.1	226.8	1207.1	0.0	130	122	0
211.5	99.8	237.1	1216.3	0.0	126	122	0
240.5	102.5	247.3	1225.4	0.0	123	122	0
269.4	105.1	257.4	1234.6	0.0	120	122	0
298.4	107.6	267.3	1243.4	0.0	141	122	0
305.6	108.2	269.9	1245.5	0.0	117	122	0
334.5	110.6	279.6	1253.4	0.0	115	122	0
363.5	113.0	289.1	1260.9	0.0	112	122	0
392.4	115.2	298.3	1261.4	0.0	110	122	0
421.4	117.3	307.3	1261.7	0.0	109	121	0
450.3	119.3	315.9	1261.7	0.0	107	119	0
479.3	121.1	323.9	1261.3	0.0	105	116	0
508.2	122.7	331.4	1260.5	0.0	104	113	0
537.2	124.0	338.4	1259.3	0.0	103	110	0
566.2	125.4	345.2	1258.0	0.0	101	109	0
595.1	126.7	352.2	1256.8	0.0	100	110	0

Flow State (continued)

Measured Depth[Flow]	Temperature	Completion Pressure	Workstring Pressure	Concentric Pressure	Completion Liquid Velocity	Workstring Liquid Velocity	Concentric Liquid Velocity
<i>m</i>	<i>Deg. F</i>	<i>psi g</i>	<i>psi g</i>	<i>psi g</i>	<i>in/s</i>	<i>in/s</i>	<i>in/s</i>
1956.0	191.4	809.6	1182.6	0.0	87	117	0
1985.0	192.8	819.8	1180.7	0.0	86	118	0
2000.8	193.6	825.4	1179.6	0.0	85	118	0
2029.7	195.0	835.7	1177.7	0.0	85	118	0
2058.7	196.4	846.1	1175.8	0.0	84	119	0
2087.6	197.9	856.5	1174.0	0.0	83	119	0
2116.6	199.4	867.2	1172.2	0.0	82	120	0
2145.5	200.9	877.9	1170.4	0.0	82	120	0
2174.5	202.4	888.8	1168.6	0.0	97	121	0
2194.6	203.5	896.4	1167.3	0.0	97	121	0
2204.0	204.0	900.0	1166.7	0.0	80	121	0
2212.7	204.5	903.6	1166.2	0.0	85	121	0
2213.0	204.5	903.7	1165.2	0.0	102	211	0
2213.7	204.5	904.0	1164.9	0.0	127	211	0
2213.7	204.5	904.2	1164.9	0.0	102	211	0
2214.7	204.6	904.6	1164.4	0.0	102	211	0
2215.0	204.6	904.8	1164.3	0.0	102	2705	0
2224.8	205.1	912.4	0.0	0.0	0	0	0
2225.0	205.1	912.5	0.0	0.0	0	0	0
2225.2	205.1	912.7	0.0	0.0	0	0	0
2232.6	205.5	918.5	0.0	0.0	0	0	0
2261.5	207.1	941.2	0.0	0.0	0	0	0
2290.5	208.7	964.3	0.0	0.0	0	0	0

Solids Bulk Cross Sectional Area

CTran Analysis

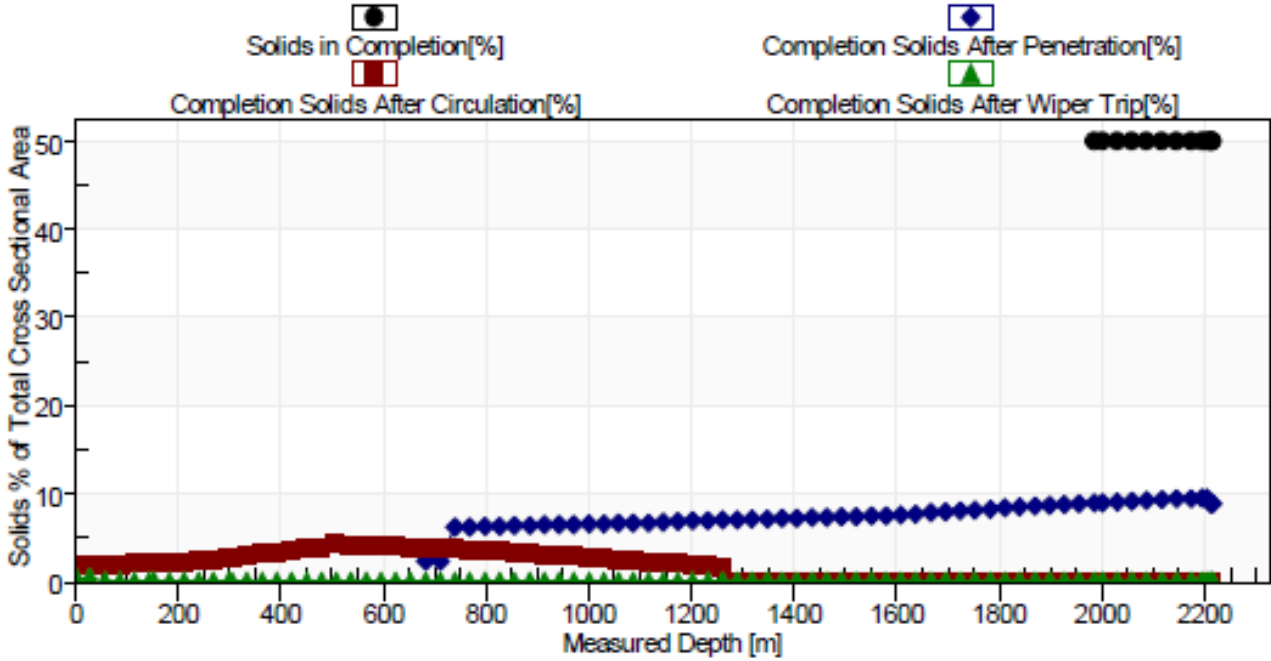

Solids Removal after Penetration to Target Depth

CTran Analysis [Transient response during Circulation and Wiper Trip]

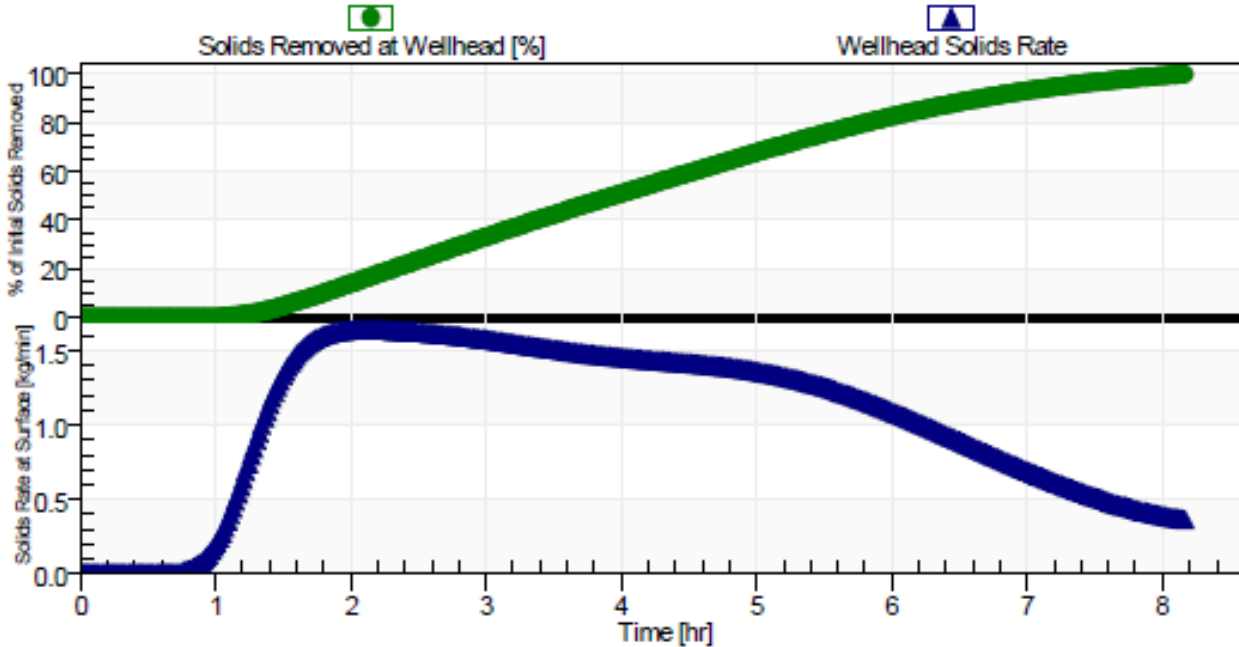

Tripping Speed to be used while Pulling Out of Hole
CTran Analysis

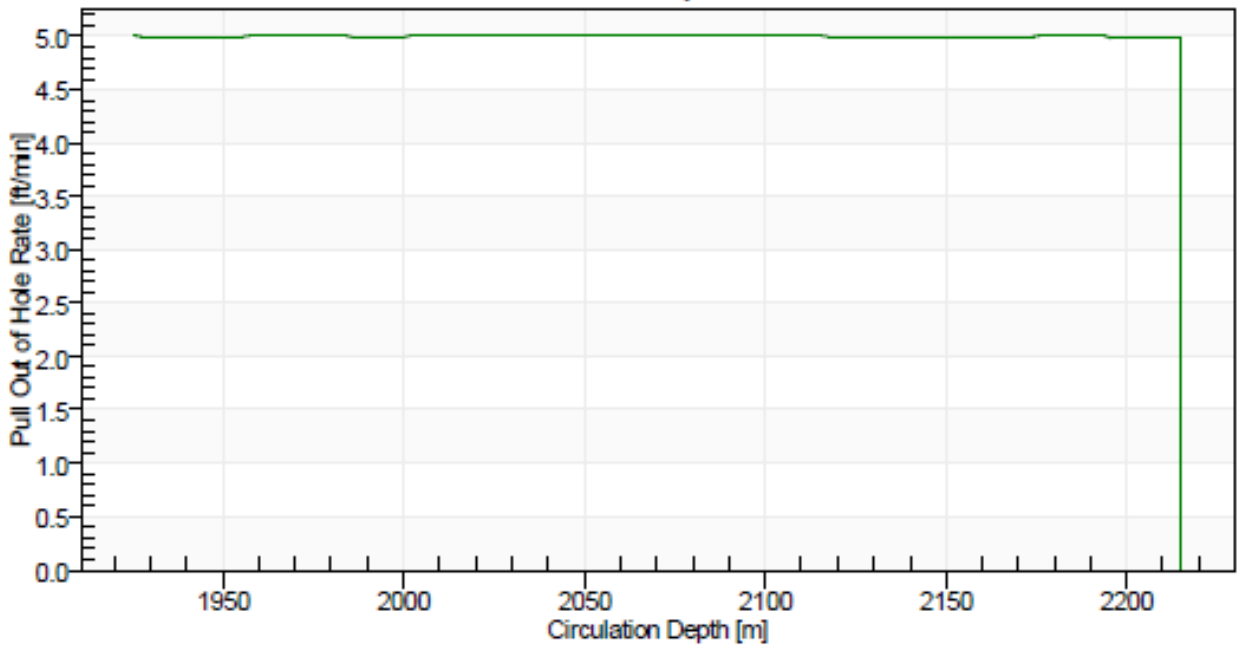

Cleanout until SSD#2 Area (Low reservoir pressure E3 – 1,500 psi)

Flow Summary

SUMMARY OF FLOW RESULTS

Produced Fluids	
Pressure known at:	Perforations
Production Mode:	No Production
Fluid Composition:	Oil and Gas
Circulated Fluids	
Fluid Composition:	Nitrified Water
Liquid:	0.80 bbl/min
Solids:	0.00 bbl/min
Gas:	400.0 scf/min
Circulation Point:	2215.00 m
HHP Required :	48.01 KW

COMPLETION:

Wellhead Pressure.....	63.3 psi g
Hydrostatic pressure loss.....	771.8 psi
Friction pressure loss.....	666.6 psi
Kinetic pressure loss.....	-2.9 psi
Restriction pressure loss.....	1.1 psi
Equivalent Circulation Density[ECD]...	6.33 lb/gal (US)
Perforation Pressure.....	1500.0 psi g
Hydrostatic pressure loss.....	185.0 psi
Bottom Hole Pressure.....	1685.0 psi g
FROM CIRCULATION POINT TO WELLHEAD:	
Liquid transit time.....	11 min
Gas transit time.....	9 min
Annular volume.....	26.2 bbl
Volume below circulation point.....	57.5 bbl
Total liquid volume.....	67.7 bbl
Total gas volume.....	16.0 bbl

(Surface equivalent).....	4019.6 scf
WORKSTRING:	
Liquid:	0.8000 bbl/min
Gas:	400 scf/min
Pressure at reel rotating joint.....	3270.4 psi g
Friction pressure loss on reel.....	1427.3 psi
Pressure inside WS at Gooseneck.....	1843.2 psi g
Hydrostatic pressure loss.....	-1159.0 psi
Friction pressure loss.....	799.9 psi
Equivalent Circulation Density[ECD]...	1.61 lb/gal (US)
BHA total pressure loss	722.5 psi
BHA Hydrostatic loss	-1.2 psi
BHA Friction loss	2.0 psi
BHA Kinetic loss	1.6 psi
Nozzle	720.1 psi
Circulation Point pressure	1479.7 psi g
FROM REEL ROTATING JOINT TO CIRCULATION POINT:	
Liquid transit time.....	17 min
Gas transit time.....	18 min
Displacement Volume.....	15.9 bbl
Internal Volume.....	22.0 bbl
Internal liquid volume.....	13.5 bbl
Internal gas volume.....	8.5 bbl
(Surface equivalent).....	6581.3 scf
Length of Workstring on reel.....	2199.88 m

Ctran Summary

SUMMARY OF HOLE CLEANING RESULTS

Initial Condition:	
% of fill interval occupied by solids before cleanout ...	50.0 %
Top of fill	1985.01 m
Deepest Circulation point	2215.01 m
Bottom of fill	2215.01 m
Initial Volume of Solids.....	2.2 bbl
Initial Mass of Solids.....	1119.1 lb
Solids type:	Mud Residue/Formation Fines
Fluid Description:	Nitrified Water
Penetration Hole Cleaning Mode:	
Penetration rate.....	5.0 ft/min
Penetration time.....	2.52 hr
Solids volume in the well after penetration	1.4 bbl
Solids mass in the well after penetration	694.1 lb
Circulation Hole Cleaning Mode:	
Hole circulation time	3.53 hr
Solids volume in the well after circulation.....	0.0 bbl
Solids mass in the well after circulation.....	0.0 lb
Volume of Fluids Pumped During Penetration & Circulation:	
Gas volume	144988.5 scf
Liquid Volume	290.0 bbl
Penetration & Circulation time	6.04 hr
Circulation results at point of Maximum Solids Head:	
BHA Depth	2215.01 m
Elapsed time	0.0000 hr
Wellhead Pressure	146.6 psi g
Additional Head created by Solids.....	13.8 psi
Maximum % solids circulated up hole was 0.6%.	
This occurred at a measured depth of	28.35 m

DIMENSION BID

DIMENSION BID COILED TUBING SERVICES



DULANG C-4 S

CEMENT PACKER

Flow State

Measured Depth[Flow]	Temperature	Completion Pressure	Workstring Pressure	Concentric Pressure	Completion Liquid Velocity	Workstring Liquid Velocity	Concentric Liquid Velocity
<i>m</i>	<i>Deg. F</i>	<i>psi g</i>	<i>psi g</i>	<i>psi g</i>	<i>in/s</i>	<i>in/s</i>	<i>in/s</i>
0.0	80.0	63.3	1843.2	0.0	207	199	0
28.4	82.6	110.9	1851.8	0.0	409	199	0
57.3	85.3	143.5	1860.6	0.0	337	199	0
86.3	88.0	172.5	1869.4	0.0	294	199	0
115.2	90.7	199.3	1877.9	0.0	265	200	0
144.2	93.4	224.7	1886.4	0.0	292	200	0
153.6	94.2	233.1	1889.1	0.0	238	200	0
182.6	96.9	257.4	1897.5	0.0	222	201	0
211.5	99.5	281.1	1905.7	0.0	210	201	0
240.5	102.1	304.4	1913.7	0.0	199	202	0
269.4	104.7	327.4	1921.1	0.0	191	203	0
298.4	107.2	350.1	1928.0	0.0	220	204	0
305.6	107.8	355.9	1929.6	0.0	182	204	0
334.5	110.2	378.2	1935.6	0.0	175	206	0
363.5	112.4	399.8	1940.4	0.0	170	207	0
392.4	114.6	420.8	1944.6	0.0	165	208	0
421.4	116.7	441.1	1947.8	0.0	161	209	0
450.3	118.7	460.5	1956.9	0.0	158	179	0
479.3	120.4	479.1	1964.2	0.0	156	179	0
508.2	122.0	496.9	1969.3	0.0	155	180	0
537.2	123.3	513.6	1972.7	0.0	153	180	0
566.2	124.7	530.1	1975.6	0.0	150	180	0
595.1	126.0	546.6	1978.9	0.0	148	180	0

Flow State (continued)

Measured Depth[Flow]	Temperature	Completion Pressure	Workstring Pressure	Concentric Pressure	Completion Liquid Velocity	Workstring Liquid Velocity	Concentric Liquid Velocity
<i>m</i>	<i>Deg. F</i>	<i>psi g</i>	<i>psi g</i>	<i>psi g</i>	<i>in/s</i>	<i>in/s</i>	<i>in/s</i>
1956.0	189.6	1321.0	2157.3	0.0	103	185	0
1985.0	191.0	1338.1	2161.6	0.0	102	185	0
2000.8	191.8	1347.5	2164.0	0.0	101	185	0
2029.7	193.2	1364.7	2168.5	0.0	101	185	0
2058.7	194.6	1382.1	2173.2	0.0	101	185	0
2087.6	196.0	1399.6	2178.2	0.0	100	186	0
2116.6	197.5	1417.4	2183.4	0.0	99	186	0
2145.5	199.0	1435.4	2188.9	0.0	99	186	0
2174.5	200.5	1453.6	2194.6	0.0	118	186	0
2194.6	201.5	1466.4	2198.6	0.0	117	186	0
2212.7	202.5	1478.0	2202.3	0.0	98	186	0
2213.0	202.5	1478.0	2200.6	0.0	116	287	0
2213.7	202.5	1478.6	2200.3	0.0	145	287	0
2213.7	202.5	1478.8	2200.3	0.0	116	287	0
2214.7	202.6	1479.5	2200.0	0.0	116	287	0
2215.0	202.6	1479.7	2199.9	0.0	116	3676	0
2224.8	203.1	1487.3	0.0	0.0	0	0	0
2225.0	203.1	1487.5	0.0	0.0	0	0	0
2225.2	203.2	1487.6	0.0	0.0	0	0	0
2241.0	204.0	1500.0	0.0	0.0	0	0	0
2281.5	205.1	1516.2	0.0	0.0	0	0	0
2290.5	206.7	1539.3	0.0	0.0	0	0	0
2319.2	208.3	1562.6	0.0	0.0	0	0	0

Solids Bulk Cross Sectional Area

CTran Analysis

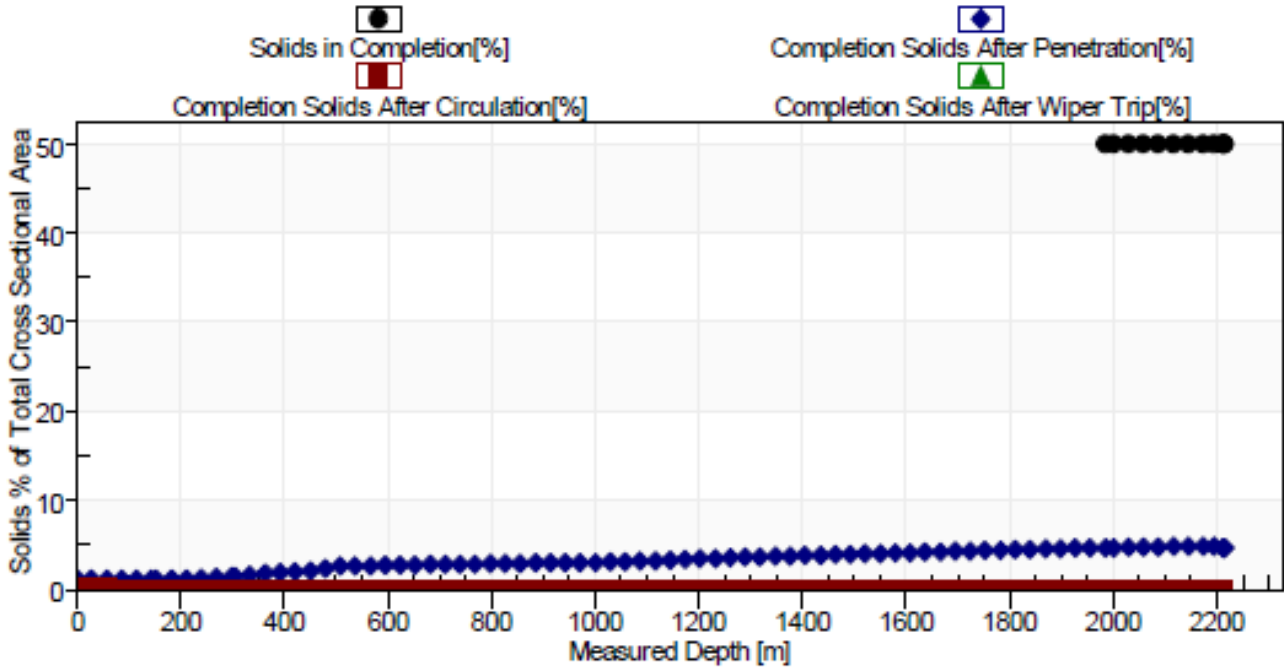

Solids Removal after Penetration to Target Depth

CTran Analysis [Transient response during Circulation and Wiper Trip]

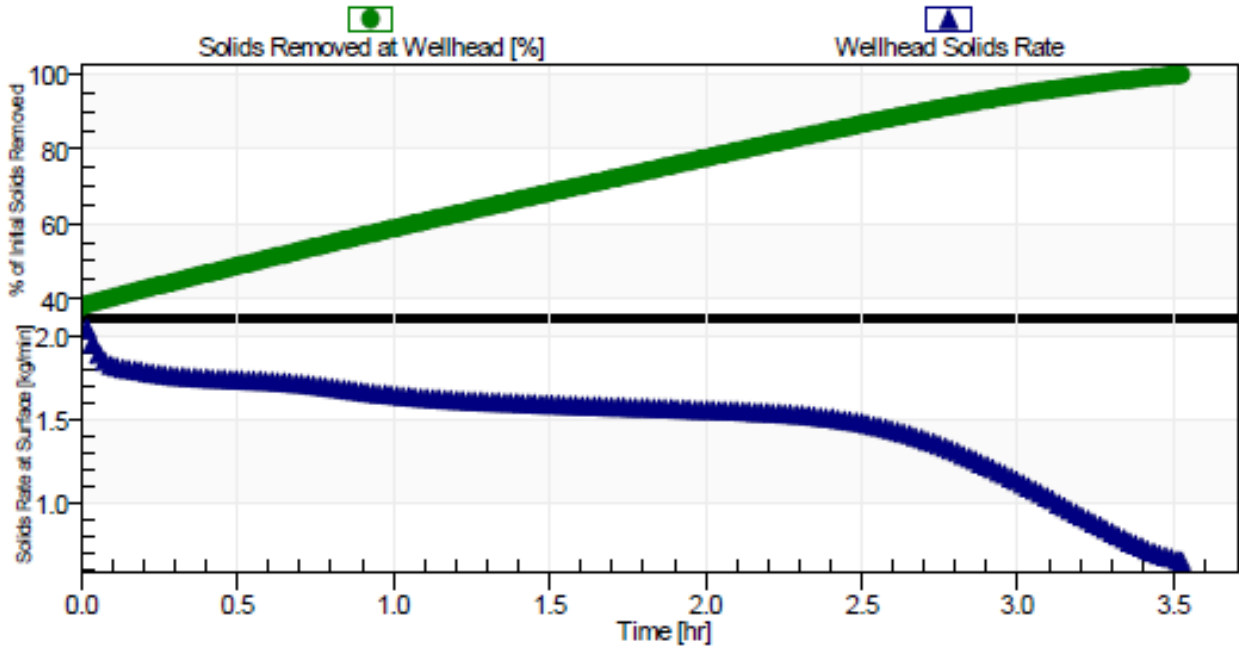

Tripping Speed to be used while Pulling Out of Hole
CTran Analysis

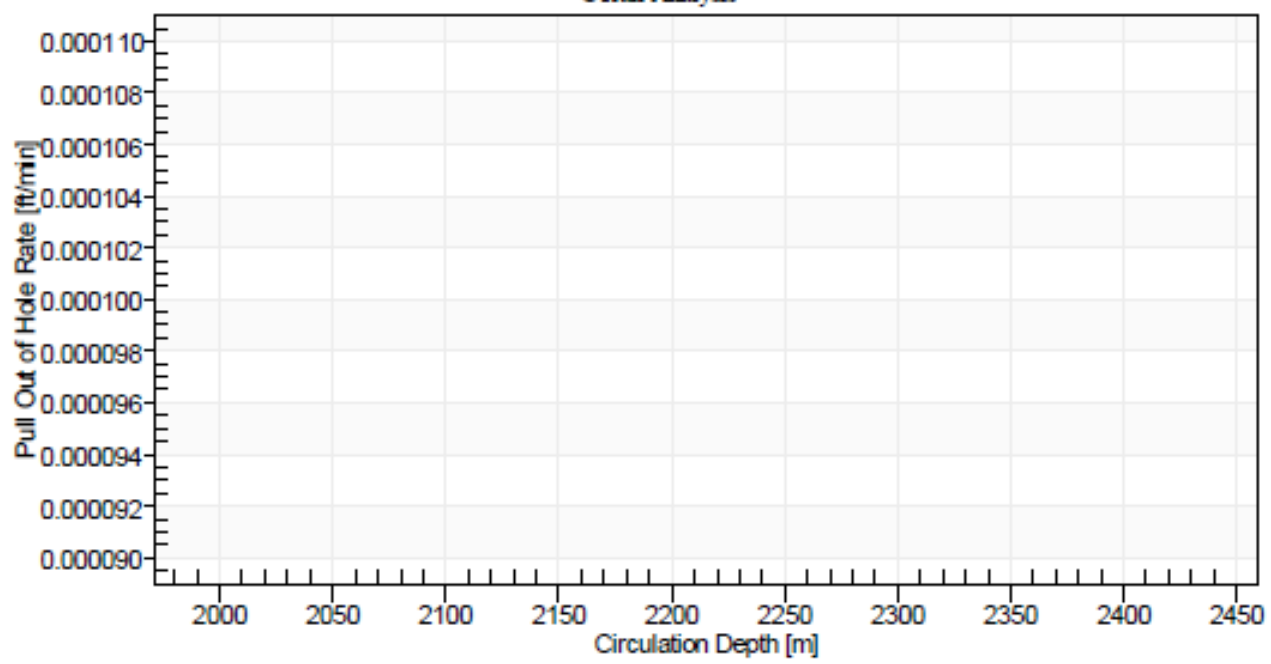

Cleanout Post Cementing

Flow Summary

SUMMARY OF FLOW RESULTS

Produced Fluids	
Pressure known at:	Perforations
Production Mode:	No Production
Fluid Composition:	Oil and Gas
Circulated Fluids	
Fluid Composition:	Nitrified Water
Liquid:	1.00 bbl/min
Solids:	0.00 bbl/min
Gas:	300.0 scf/min
Circulation Point:	2170.00 m
HHP Required :	83.18 KW

COMPLETION:

Wellhead Pressure.....	244.0 psi g
Hydrostatic pressure loss.....	1025.2 psi
Friction pressure loss.....	605.3 psi
Kinetic pressure loss.....	-3.9 psi
Restriction pressure loss.....	0.4 psi
Equivalent Circulation Density[ECD]...	7.40 lb/gal (US)
Perforation Pressure.....	1871.0 psi g
Hydrostatic pressure loss.....	239.9 psi
Bottom Hole Pressure.....	2110.9 psi g
FROM CIRCULATION POINT TO WELLHEAD:	
Liquid transit time.....	12 min
Gas transit time.....	11 min
Annular volume.....	25.6 bbl
Volume below circulation point.....	58.4 bbl
Total liquid volume.....	72.4 bbl
Total gas volume.....	11.6 bbl

(Surface equivalent).....	3821.4 scf
 WORKSTRING:	
Liquid:	1.0000 bbl/min
Gas:	300 scf/min
Pressure at reel rotating joint.....	4538.0 psi g
Friction pressure loss on reel.....	1776.3 psi
 Pressure inside WS at Gooseneck.....	 2761.7 psi g
Hydrostatic pressure loss.....	-1254.7 psi
Friction pressure loss.....	1255.0 psi
Equivalent Circulation Density[ECD]..	0.02 lb/gal (US)
 BHA total pressure loss	 890.3 psi
BHA Hydrostatic loss	-1.2 psi
BHA Friction loss	4.2 psi
BHA Kinetic loss	1.5 psi
Nozzle	885.8 psi
 Circulation Point pressure	 1871.0 psi g
 FROM REEL ROTATING JOINT TO CIRCULATION POINT:	
Liquid transit time.....	16 min
Gas transit time.....	21 min
Displacement Volume.....	15.6 bbl
Internal Volume.....	22.0 bbl
Internal liquid volume.....	15.7 bbl
Internal gas volume.....	6.2 bbl
(Surface equivalent).....	6264.4 scf
 Length of Workstring on reel.....	 2244.88 m

Ctran Summary

SUMMARY OF HOLE CLEANING RESULTS

Initial Condition:	
% of fill interval occupied by solids before cleanout ...	50.0 %
Top of fill	2000.01 m
Deepest Circulation point	2169.99 m
Bottom of fill	2169.99 m
Initial Volume of Solids.....	1.6 bbl
Initial Mass of Solids.....	1131.5 lb
Solids type:	20/40 Bauxite Proppant
Fluid Description:	Nitrified Water
Penetration Hole Cleaning Mode:	
Penetration rate.....	10.0 ft/min
Penetration time.....	0.93 hr
Solids volume in the well after penetration	1.6 bbl
Solids mass in the well after penetration	1131.5 lb
Circulation Hole Cleaning Mode:	
Hole circulation time	2.00 hr
Solids volume in the well after circulation.....	0.9 bbl
Solids mass in the well after circulation.....	644.7 lb
Wiper Trip Hole Cleaning Mode:	
Wiper Trip Scheme:	User Specified rate, Tornado not
Wiper trip time	1.92 hr
Solids volume in the well after wiper trip	0.0 bbl
Solids mass in the well after wiper trip	0.0 lb
Volume of Fluids Pumped During Penetration, Circulation & Wiper Trip:	
Gas volume	87352.5 scf
Liquid Volume	291.2 bbl
Penetration, Circulation & Wiper Trip time	4.85 hr

Circulation results at point of Maximum Solids Head:

BHA Depth	2169.99 m
Elapsed time	1.3980 hr
Wellhead Pressure	286.1 psi g
Additional Head created by Solids.....	24.9 psi
Maximum % solids circulated up hole was 0.8%.	
This occurred at a measured depth of	1122.27 m
after the transient had run for	0.0 hr

DIMENSION BID

DIMENSION BID COILED TUBING SERVICES



DULANG C-4 S

CEMENT PACKER

Flow State

Measured Depth[Flow] <i>m</i>	Temperature <i>Deg. F</i>	Completion Pressure <i>psi g</i>	Workstring Pressure <i>psi g</i>	Concentric Pressure <i>psi g</i>	Completion Liquid Velocity <i>in/s</i>	Workstring Liquid Velocity <i>in/s</i>	Concentric Liquid Velocity <i>in/s</i>
0.0	80.0	244.0	2761.7	0.0	198	208	0
27.2	82.6	267.9	2773.4	0.0	187	208	0
56.4	85.4	293.6	2786.1	0.0	178	208	0
85.7	88.2	319.2	2798.7	0.0	170	208	0
114.9	91.0	344.7	2811.1	0.0	163	208	0
144.2	93.8	370.3	2823.3	0.0	188	209	0
152.1	94.5	377.4	2826.6	0.0	155	209	0
181.4	97.3	403.0	2838.8	0.0	150	209	0
210.6	100.0	428.7	2850.8	0.0	145	210	0
239.9	102.7	454.4	2862.4	0.0	141	210	0
269.1	105.4	479.9	2873.5	0.0	138	211	0
298.4	108.0	505.1	2883.9	0.0	161	212	0
302.9	108.4	509.1	2885.4	0.0	134	212	0
332.1	110.9	533.9	2894.7	0.0	131	213	0
361.4	113.3	558.0	2902.8	0.0	129	214	0
390.7	115.6	581.6	2910.0	0.0	126	215	0
419.9	117.8	604.6	2916.0	0.0	124	216	0
449.2	119.8	626.6	2920.4	0.0	122	216	0
478.4	121.6	647.2	2922.8	0.0	121	216	0
507.7	123.3	666.2	2922.9	0.0	119	215	0
537.0	124.7	683.8	2921.0	0.0	118	214	0
566.2	126.0	701.1	2913.7	0.0	117	171	0
595.5	127.5	718.7	2906.5	0.0	116	171	0

Flow State (continued)

Measured Depth[Flow]	Temperature	Completion Pressure	Workstring Pressure	Concentric Pressure	Completion Liquid Velocity	Workstring Liquid Velocity	Concentric Liquid Velocity
<i>m</i>	<i>Deg. F</i>	<i>psi g</i>	<i>psi g</i>	<i>psi g</i>	<i>in/s</i>	<i>in/s</i>	<i>in/s</i>
1970.7	193.8	1710.1	2778.2	0.0	105	225	0
2000.0	195.2	1733.5	2775.2	0.0	104	225	0
2021.4	196.3	1750.6	2773.2	0.0	102	226	0
2050.7	197.8	1774.0	2770.4	0.0	101	226	0
2079.9	199.2	1797.5	2767.8	0.0	101	226	0
2109.2	200.8	1821.2	2765.4	0.0	100	227	0
2138.5	202.3	1845.1	2763.4	0.0	99	227	0
2167.7	203.9	1869.1	2761.4	0.0	98	228	0
2168.0	203.9	1869.2	2759.5	0.0	115	354	0
2168.7	203.9	1869.9	2758.5	0.0	115	354	0
2169.7	204.0	1870.8	2757.3	0.0	115	354	0
2170.0	204.0	1871.0	2756.9	0.0	115	4537	0
2174.5	204.2	1874.4	0.0	0.0	0	0	0
2194.6	205.3	1889.9	0.0	0.0	0	0	0
2213.7	206.4	1904.7	0.0	0.0	0	0	0
2224.8	207.0	1913.4	0.0	0.0	0	0	0
2225.0	207.0	1913.5	0.0	0.0	0	0	0
2225.2	207.0	1913.7	0.0	0.0	0	0	0
2232.0	207.4	1919.0	0.0	0.0	0	0	0
2261.2	209.0	1942.0	0.0	0.0	0	0	0
2290.5	210.6	1965.3	0.0	0.0	0	0	0
2317.7	212.2	1987.4	0.0	0.0	0	0	0
2347.0	213.9	2011.5	0.0	0.0	0	0	0

Solids Bulk Cross Sectional Area

CTran Analysis

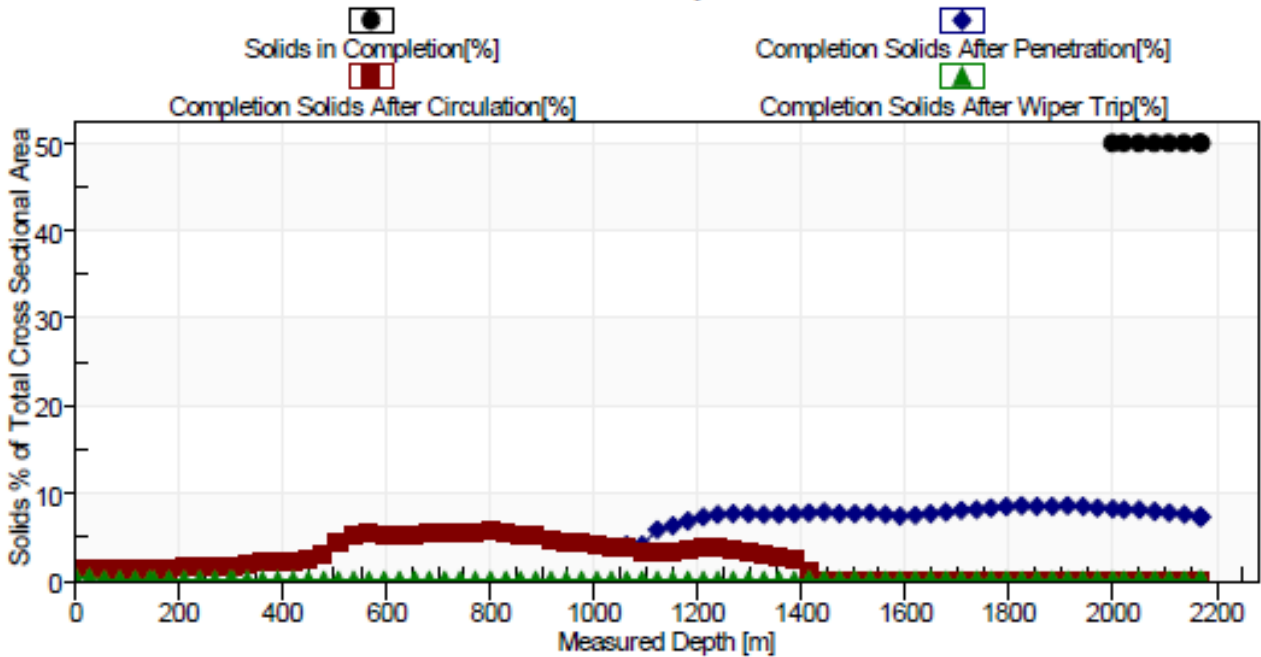

Solids Removal after Penetration to Target Depth

CTran Analysis [Transient response during Circulation and Wiper Trip]

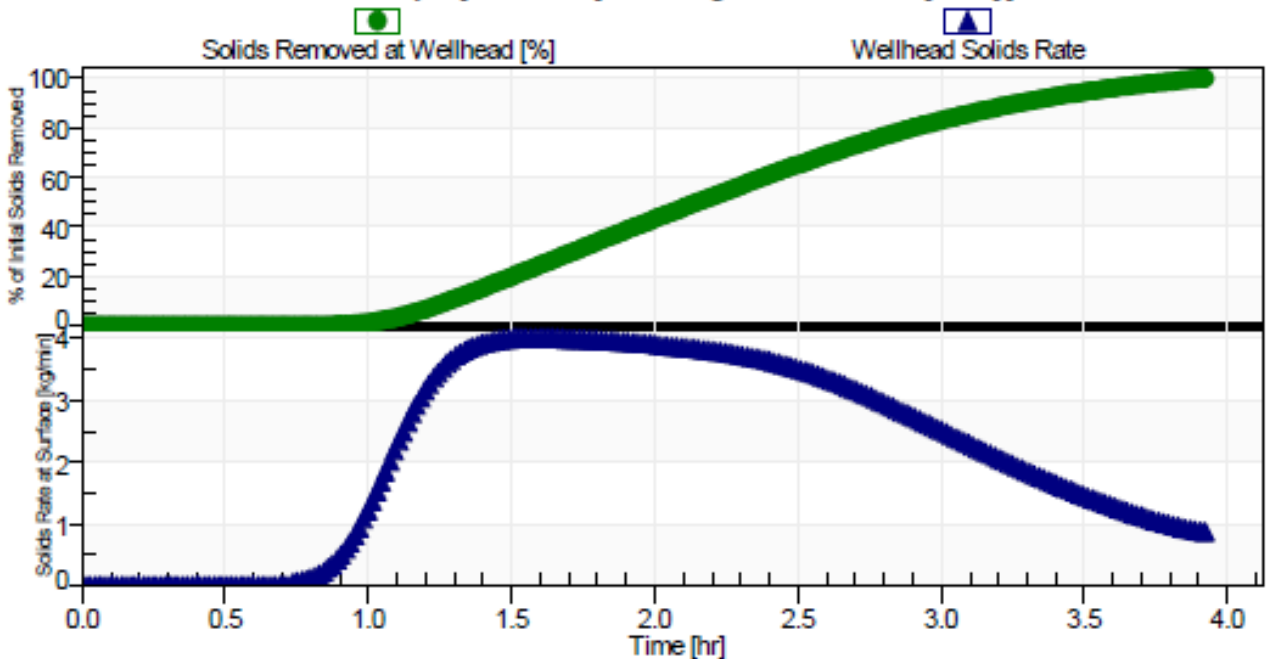

APPENDIX VII – CERBERUS CEMENT PUMPING SIMULATION

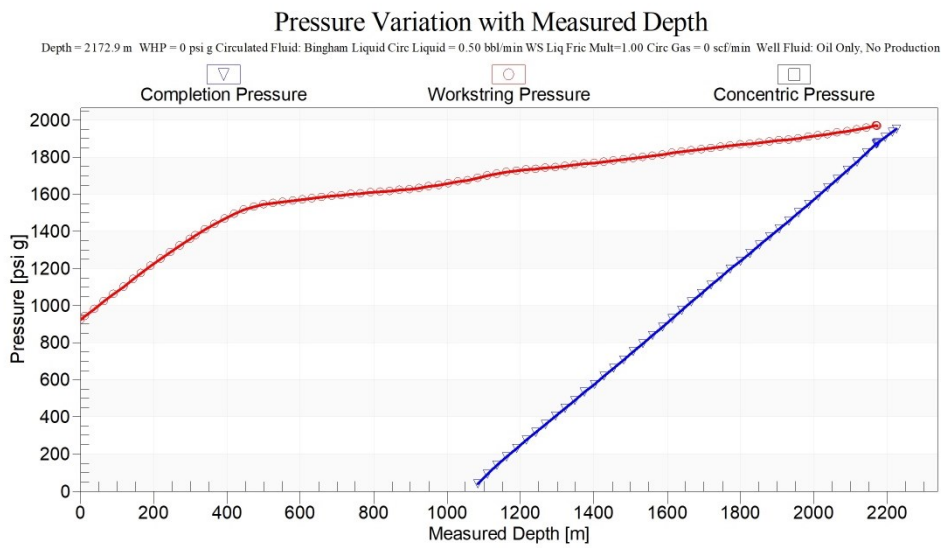
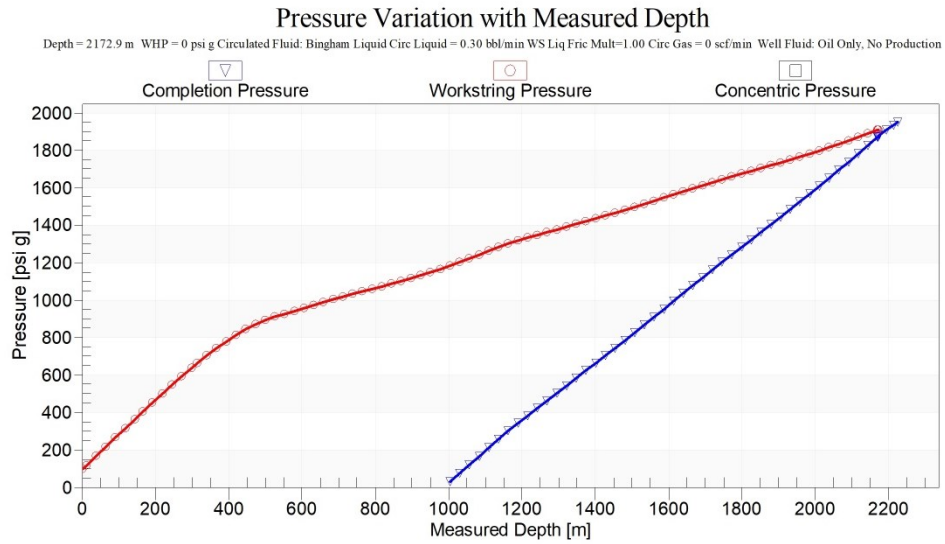

Pressure Variation with Measured Depth

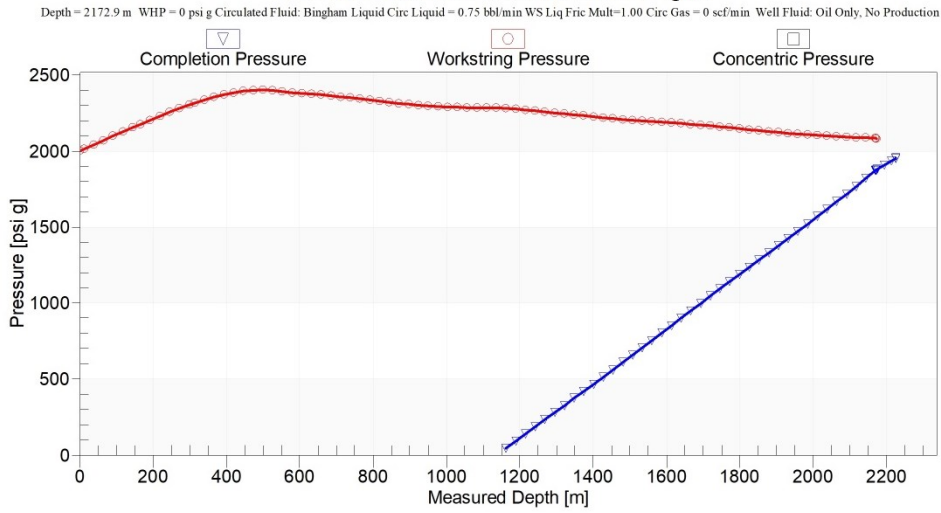

Pressure Variation with Measured Depth

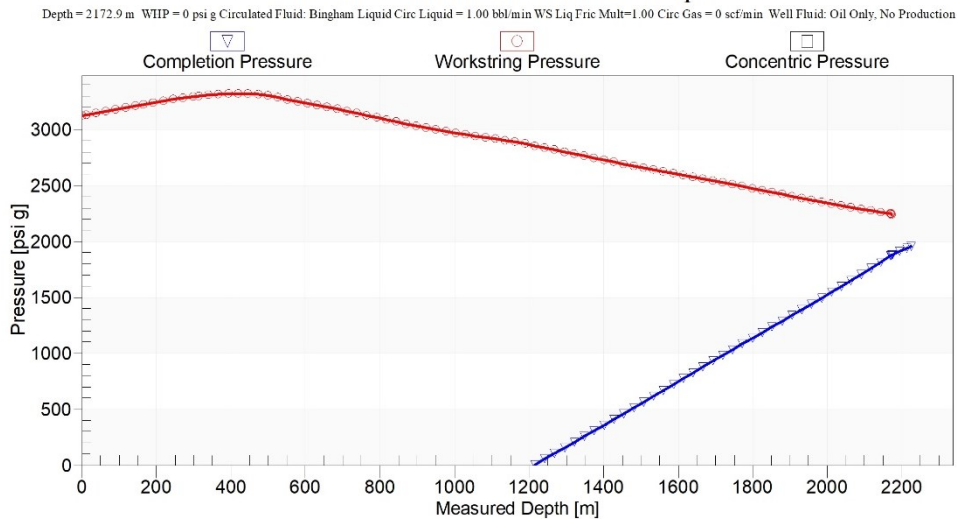

Pressure Variation with Measured Depth

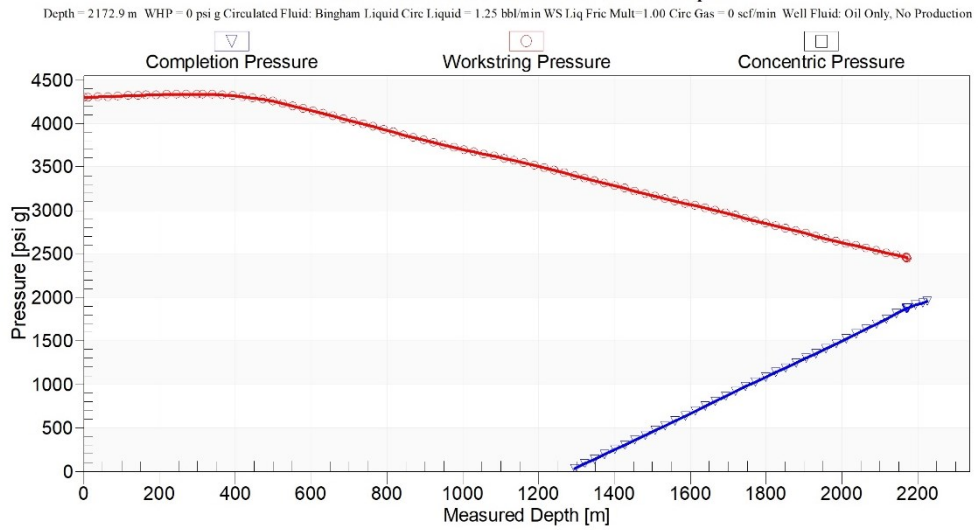

Pressure Variation with Measured Depth

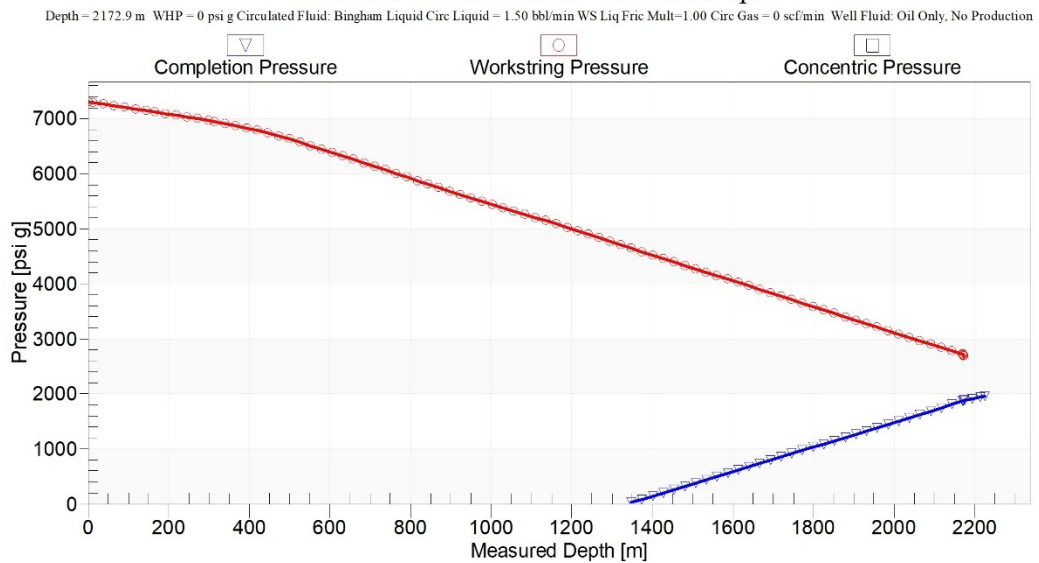

APPENDIX VIII – CEMENT LAB REPORT

CLIENT/WELL INFORMATION

Client Name	Dimension Bid			District	Kemaman
Well Name	C-4S	MD	7120 ft	Date Requested	03.10.2023
Well Type	Production	TVD	4243 ft	Date Result Needed	09.10.2023
Well Location	DULANG	TG	-	Tubing Size	-
Job Type	CT ZONE SHUT Off	WD	63.5 m	Casing Size	7"
Job Description	-	BHST	212 degF	Mud Type	Seawater
Rig	-	Surface Temp	90 degF	Mud Density	8.7 ppg
Platform	Dulang	BHsQT	-	PG	-

SLURRY DESIGN

Slurry ID	SVP-CMT-LAB-KMM-C0250	Slurry Type	Plug	Slurry Description	Dulang C-4S
-----------	-----------------------	-------------	------	--------------------	-------------

SLURRY PROPERTIES

Slurry Density	15.0 ppg	Liquid Volume	73.7 %
Slurry Yield	1.231cu.ft/sk	Total Mix Fluid	5.825 gal/sk
Mix Water	3.815 gal/sk		

SLURRY COMPOSITION

Component Type	Component	Concentration	Lot/Batch	Source
Cement	BLENDED SLAGMENT	100.00% BWOC	N/A	CLIENT
Anti-Foam Additive	SFP 0006	0.05 GPS	11BCA05026	KMM
Bonding Agent Additive	SBA 0016	1.55 GPS	04/03/22-2	KMM
Fluid Loss Additive	SFL 0016	0.15 GPS	CY91371004	KMM
Cement Dispersant Additive	SCD 0003	0.20 GPS	2103/22	KMM
Cement Retarder Additive	SCR 0025	0.06 GPS	1702/21	KMM
Expanding Agent	SBA 0010	0.5 %	N/A	KMM
Water	Seawater	3.815 gal/sk	30/8/2023	DULANG

TEMPERATURE – PRESSURE PROFILES AND RESULTS

Results:	Thickening Time	Start Time	09:00 AM
		Stop Time	12:00 PM
Start ID Analyst	DIN	Start Date	04.10.2023
Stop ID Analyst	DIN	Stop Date	04.10.2023
		Equipment ID	CON368
Test Temperature	212 degF		
Test Pressure	2100 psi		
40BC	15:58 HH:MM		
70BC	16:04 HH:MM		
100BC	16:08 HH:MM		
Batch Mixing Simulation	180 min		
Ramp time to BHST	30min		

	Time (Min)	Motor Status)	Continous Time, minutes
Batch Mixer Time (3 Hour)	191 min	On	191
1st Go-No-GO	20 min	Off	211
Pumping time (1:32 Hour), Half time	46 min	On	256
2nd Go-No-GO	20 min	Off	276
Complete pump, deploy Cement dart	46 min	On	322
3rd Go-No-GO	20 min	Off	342
Pump SW to displace cement n push darto Connector	48 min	On	390
4th Go-No-Go	20 min	Off	410

Contino on motor until end of test

DIMENSION BID

DIMENSION BID COILED TUBING SERVICES



DULANG C-4 S

CEMENT PACKER

Profile:

Thickening Time

Description:

Sequence followed as per LAR.

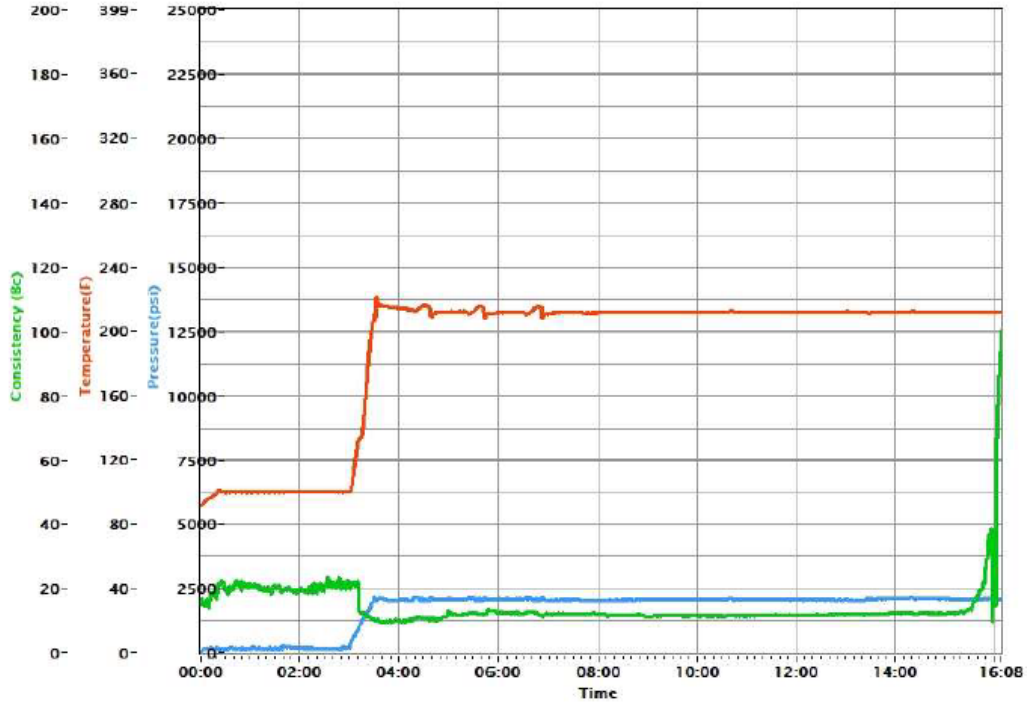

DIMENSION BID

DIMENSION BID COILED TUBING SERVICES



DULANG C-4 S

CEMENT PACKER

Results:	Compressive Strength – Non-Destructive	Start Time	02:30 PM
Start ID Analyst	DIN	Stop Time	02:45 PM
Stop ID Analyst	DIN	Start Date	07.10.2023
Equipment ID	SGSA	Stop Date	08.10.2023
50 psi		15:37 HH:MM	
500 psi		16:40 HH:MM	
1000 psi		17:35 HH:MM	
12 hr		0 Psi	
24 hr		2287 Psi	
Final Strength (22:51 HR:MM)		2450 Psi	
Final Time		2251 HH:MM	
Test Temperature		212 deg F	
Test Pressure		2100 psi	
Surface Temperature Sample		5 days	
Water Bath Sample		2 days	

Start Test: 7/10/2023 5:36:26 PM
 Stop Test: 8/10/2023 4:30:20 PM
 SG5100: 15:46:30
 SG5500: 15:46:30

Compressive Strength: 2287 psi
 Transition Time: 00:02:00

50psi 15:37:00
 500psi 16:40:00
 1000psi 17:35:00
 12Hrs 0 psi

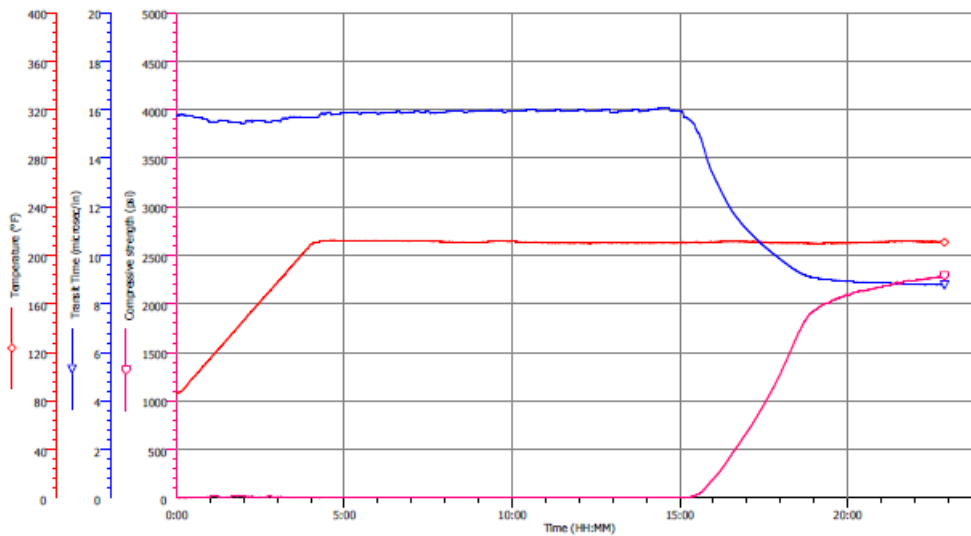

DIMENSION BID

DIMENSION BID COILED TUBING SERVICES



DULANG C-4 S

CEMENT PACKER

Results:	Static Gel-Strength Analyzer	Start Time	02:30 PM
Start ID Analyst	DIN	Stop Time	02:45 PM
Stop ID Analyst	DIN	Start Date	07.10.2023
Equipment ID	SGSA	Stop Date	08.10.2023
100 lbf/100ft2		15:44 HH:MM	
500 lbf/100ft2		15:46 HH:MM	
Transit Time		00:02 HH:MM	
Test Temperature		212 degF	
Test Pressure		2100 psi	

Profile:	Static Gel-Strength Analyzer- Non-Destructive	Description:	BHST of 212F
-----------------	--	---------------------	--------------

Start Test: 7/10/2023 5:36:26 PM
 Stop Test: 8/10/2023 4:30:20 PM
 SGS100 : 15:44:30
 SGS500 : 15:46:30

Compressive Strength: 2287 psi
 Transition Time: 00:02:00

50psi 15:37:00
 500psi 16:40:00
 1000psi 17:35:00
 12Hrs 0 psi

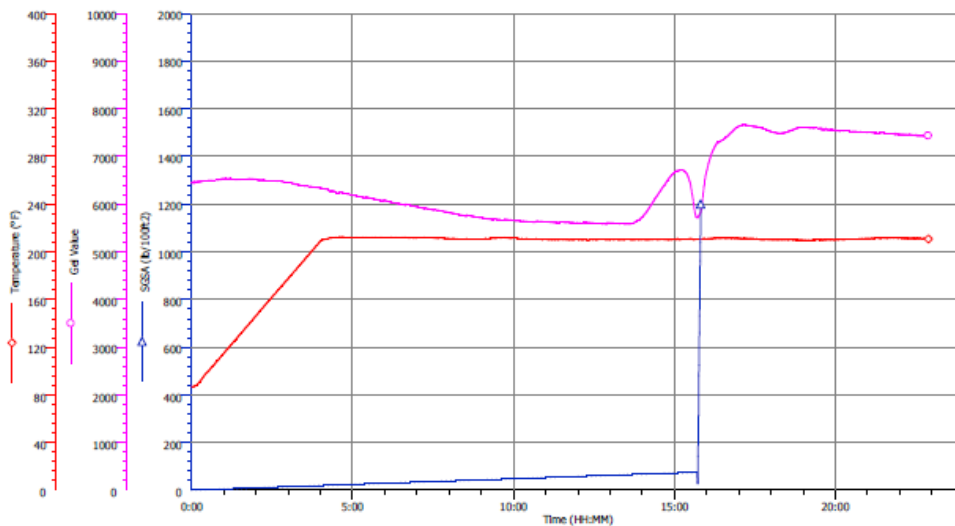

DIMENSION BID

DIMENSION BID COILED TUBING SERVICES



DULANG C-4 S

CEMENT PACKER

Results:	Fluid Loss – Static Cell (Screw-in End Caps)	Start Time	02:30 PM
Start ID Analyst	DIN	Stop Time	03:00 PM
Stop ID Analyst	DIN	Start Date	03.10.2023
Equipment ID	84300	Stop Date	03.10.2023
Heat –up Schedule	10 min to 212 degF Test Temperature (5.1degF/min, 0kpsi)		
Conditioning Method	Atmospheric Consistometer (30 minutes)		
Static Cell Length	10 inches		
Cell Type (Ends)	Double		
Screen Type	325 mesh X 60 mesh		
If filtrate weighted, relative density	1.02 SG at 80 degF		
API Fluid Loss	44 cc API		
Blowout	-		
Calculated API Fluid Loss	-		
Filter Cake Condition	Thickness = 10mm Consistency = Gelled		
Time From End Of Conditioning To Test Start	2 min		
Temperature	Start Test = 194 degF End of Test = 212 degF		
Location Of Thermocouple	In Slurry		

Results:	Free Fluid	Start Time	3:00 PM
Start ID Analyst	DIN	Stop Time	5:00 PM
Stop ID Analyst	DIN	Start Date	03.10.2023
Equipment ID	FF1	Stop Date	03.10.2023
Length Of Graduated Tube Section	-	Mm	
Graduated Tube Inner Diameter	-	Mm	
Slurry Volume	250 MI		
Final Temperature	194 degF		
Time To Final Temperature	32 min		
Conditioning Temperature	194 degF		
Deviation Angle	45 deg.		
Final Test Pressure	0 psi		
Measured Free Fluid Volume	0 mL		
% Free Fluid	0.00%		
Channeling	No		
Settling	No		

Results:	Rheology – Temp 1	Start Time	02:00 PM
Start ID Analyst	ZULAIHA	Stop Time	02:30 PM
Stop ID Analyst	ZULAIHA	Start Date	03.10.2023
Equipment ID	13065	Stop Date	03.10.2023
Test Temperature		80 degF	
PV		114.75 Cp	
YP		13.25 lbf/100ft2	
10 sec gel strength		3 lbf/100ft2	
10 min gel strength		4 Lbf/100ft2	

RPM	300	200	100	6	3
Up	128	88	51	7	3
Dwn		90	52	7	3
Avg	128	89	51.5	7	3

Results:	Rheology – Temp 2	Start Time	02:30 PM
Start ID Analyst	ZULAIHA	Stop Time	03:00 PM
Stop ID Analyst	ZULAIHA	Start Date	03.10.2023
Equipment ID	13065	Stop Date	03.10.2023
Test Temperature		194 degF	
PV		68.25 Cp	
YP		13.75 bf/100ft2	
10 sec gel strength		3 lbf/100ft2	
10 min gel strength		3 Lbf/100ft2	

RPM	300	200	100	6	3
Up	82	62	38	7	2
Dwn		60	35	3	2
Avg	82	61	36.5	5	2

DISCUSSION

1. Water Temperature = 28degC
2. Cement Blend Temperature = 28degC
3. Time to Mix (Time to wet) = 22 sec
4. Yield Calculation Based on 74 lbs/sack
5. Chemical sequences mixing order as per below;
 - a. SFP 0006
 - b. SBA 0016
 - c. SFL 0016
 - d. SCD 0003
 - e. SCR 0025
 - f. BLENDED SLAGMENT
 - g. SBA 0010
6. Averages speed mixing was at 12115 rpm for 35 Second.

APPENDIX**ACRONYMS AND DEFINATIONS**

GG	GEO THERMAL GRADIENT
PG	PRESSURE GRADIENT
WD	WATER DEPTH
TVD	TRUE VERTICAL DEPTH
MD	MEASURED DEPTH
BHST	BOTTOM HOLE STATIC TEMPERATURE