

SLICKLINE ASSISTANT WORKBOOK

IMPORTANT NOTE:

1. Your point of reference to complete this workbook may be obtained from the following
 - Training Manual and any other training materials provided together with this workbook
 - Your Trainer, Assessor (Slickline Operator), Verifier (FSM) or senior colleagues
 - SOP / Quality Procedures & Processors
2. The completion of this Workbook is a joint effort and responsibility between you and your assessor therefore you have the obligation to request from your assessor to be assessed upon your completion of each topic
3. The completion of this Workbook is part of the MANDATORY requirements which you must fulfill to qualify for a promotion
4. Your training program is mostly self-driven, including this Workbook. It requires individual initiatives, dedication and commitment to complete the process.

NAME	MUHD NUR SELAMAT BIN TAMRIL
DATE OF JOIN	11/11/2024
CONTACT NO.	0109371028
RECEIVED DATE	11/11/2025
DATE COMPLETED	3/3/2025

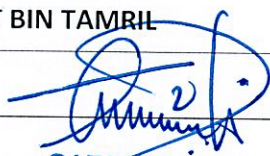

GAZALI MEHRY
 Operation Manager
 Dimension Bid (M) Sdn Bhd
 Labuan Warehouse
 Slickline Services

4/3/25

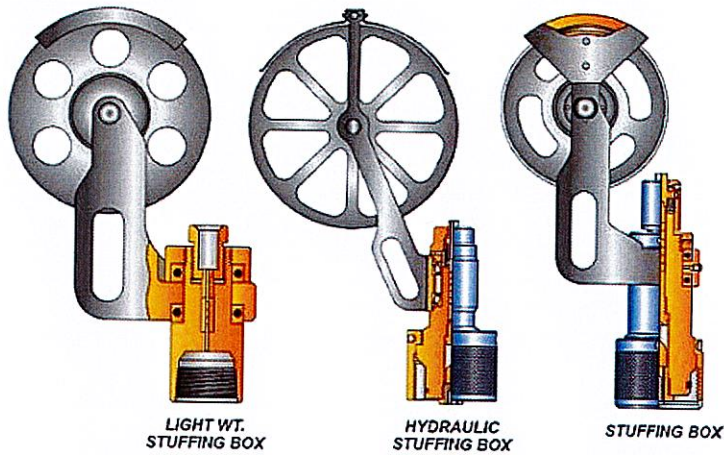

B. SURFACE EQUIPMENT

B.1. STUFFING BOX



What is Stuffing Box

- Primary pressure barrier that positioned at the uppermost point of the pce string



What is the purpose of stuffing Box

- To ensure sealing off around moving or solid wireline at the upper end the lubricator during wireline operations



How to operate Stuffing Box

- Stuffing box can be operated either manually or hydraulically without part modification



GAZALI MEHRY
Operation Manager
Dimension Bid (M) Sdn Bhd
Labuan Warehouse
Stickline Services

4/8/25

What is maintenance required for Stuffing Box

Packings	
- Not worn out.	✓
Sheave	
- Use correct size	✓
Upper and lower gland	✓
- Check for wear	
BOP plunger	
- Check for wear and freedom of vertical movement	
Sheave bearings	
- Check for free spinning	✓
Sheave staff	
- Check for freedom of swivel movement	✓
Sheave guard	
- Tight and adjusted close to the sheave	✓

What is safety precaution required for Stuffing Box

Check the packing whether worn out or not	✓
Check out the correct size of the sheave	

What is potential hazard during handling Stuffing Box

Drop object	
Pinch point	✓
Back injury	



GAZALI MEHRY
Operation Manager
Dimension Bid (M) Sdn Bhd
Labuan Warehouse
Slickline Services

4/3/25



Draw & name each part of stuffing box

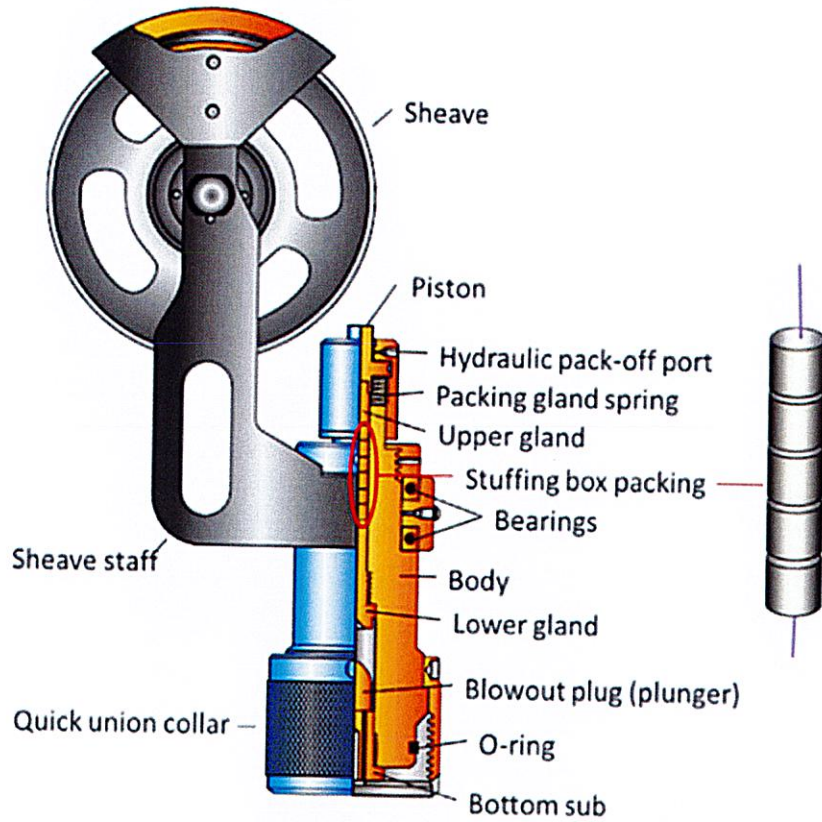

GAZALI MEHRY
Operation Manager
Dimension Bid (M) Sdn Bhd
Labuan Warehouse
Slickline Services

4/3/25



B.2. LUBRICATOR

What is Lubricator

- Lubricator is also known as risers are series of inter-connected lengths of pipe. It is a piece of equipment designed to enable wireline tool string to be introduced or retrieve from a wellbore under pressure ✓

What is the purpose of Lubricator

- is to provide a space for the tool to be contained in under pressure, when opening and closing the wellhead ✓

How to operate Lubricator

- Connect the lubricator section using chain block, wireline mast, crane or gin pole ✓

What is maintenance required for Lubricator

- Check for any cracks
Visually inspect at the regular interval
Check all the O-ring and make sure that it didn't worn out ✓

GAZALI MEHRY
Operation Manager
Dimension Bid (M) Sdn Bhd
Labuan Warehouse
Slickline Services

4/3/25



What is safety precaution required for Lubricator

- Lubricator should be x-rayed ✓
- One of the lubricators must have a port to bleed of pressure

What is potential hazard during handling Lubricator

- Drop object ✓
 - Pinch point ✓
 - Back injury ✓
- GAZALI MEHRY*
Operation Manager
Dimension Bid (M) Sdn Bhd
Labuan Warehouse
Slickline Services
4/8/25

Draw & name each part of Lubricator

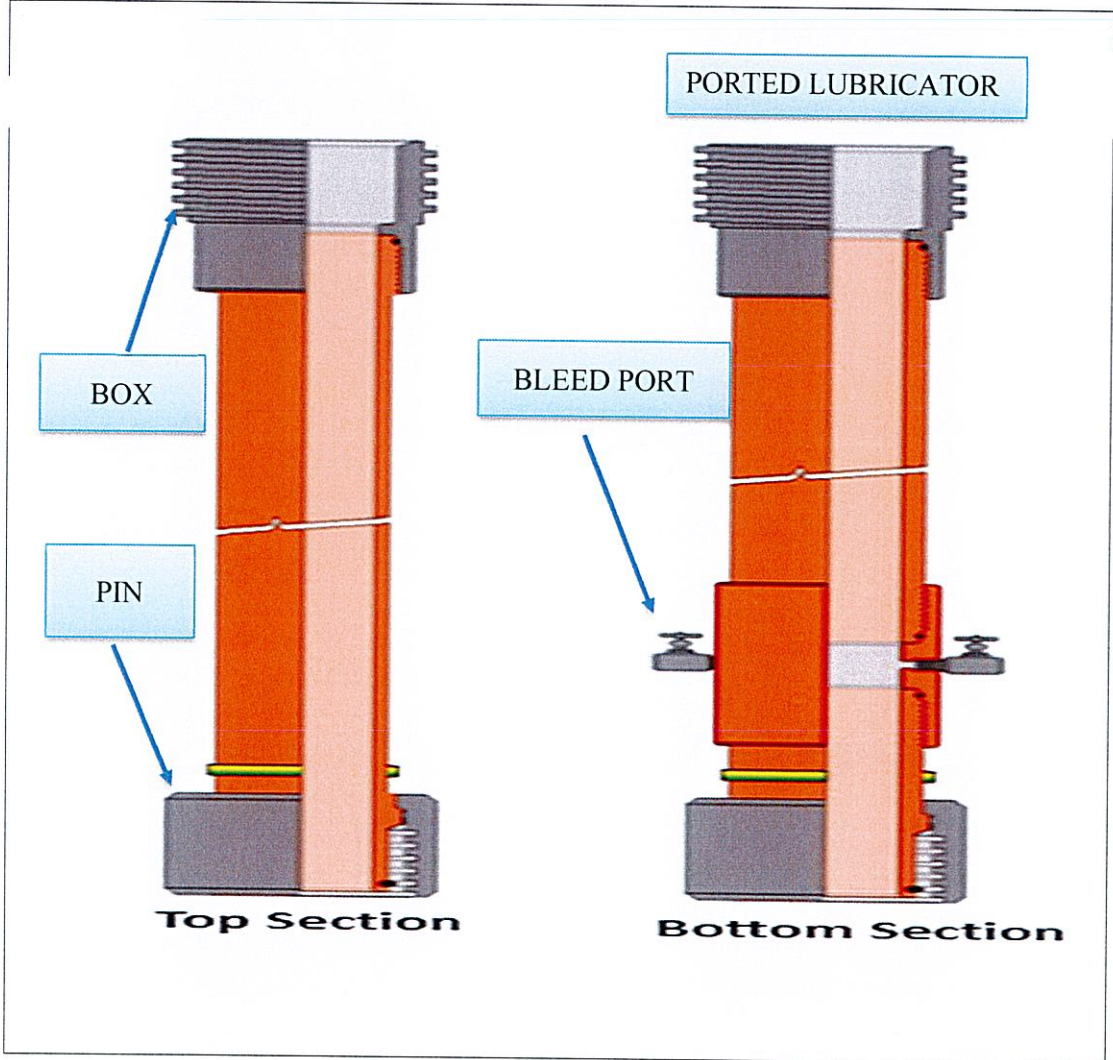



B.3. BLOWOUT PREVENTER (BOP)

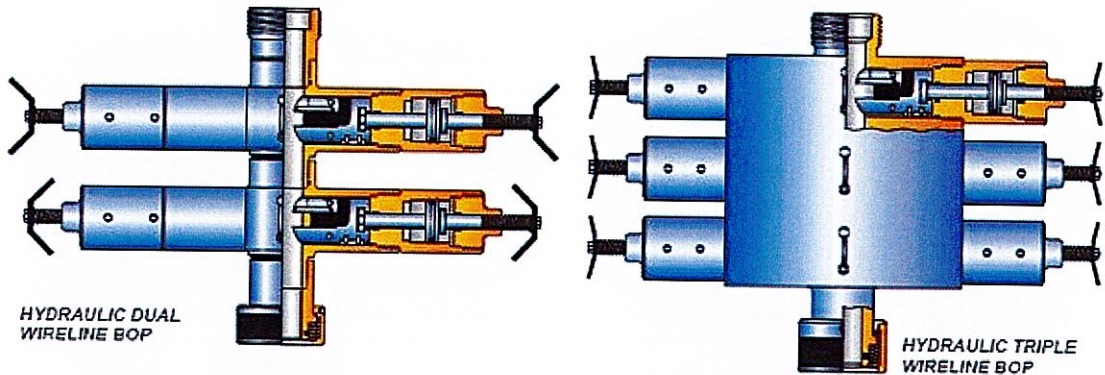

What is BOP

- A BOP also known as a wireline valve is installed between the tree connection and lower lubricator section ✓

What is the purpose of BOP

- Enable the well pressure to be isolated without cutting the wire by closing the master valve. ✓
- Permit the assembly of the wireline cutter above the BOP rams and dropping it if the tool string becomes stuck in the well ✓
- Allow slickline work to be conducted while containing the well pressure on surface with wire in the wellbore ✓

How to operate BOP

- Using RSU/CP/WCP to operate BOP ✓

GAZALI MEHRY
 Operation Manager
 Dimension Bid (M) Sdn Bhd
 Labuan Warehouse
 Slickline Services
 4/3/25



What is maintenance required for BOP

- service and need to be pressure tested
- Level 1 Service - To be carried out after every job
- Level 2 Service - To be carried out once a year
- Level 3 Service - To be carried out every 5 years



What is safety precaution required for BOP

- Ensure the rod has enlarged diameter below the ram to prevent it being blown out during testing.



What is potential hazard during handling BOP

- High pressure
- Hose burst



GAZALI MEHRY
Operation Manager
Dimension Bid (M) Sdn Bhd
Labuan Warehouse
Slickline Services

4/3/25

Draw & name each part of BOP

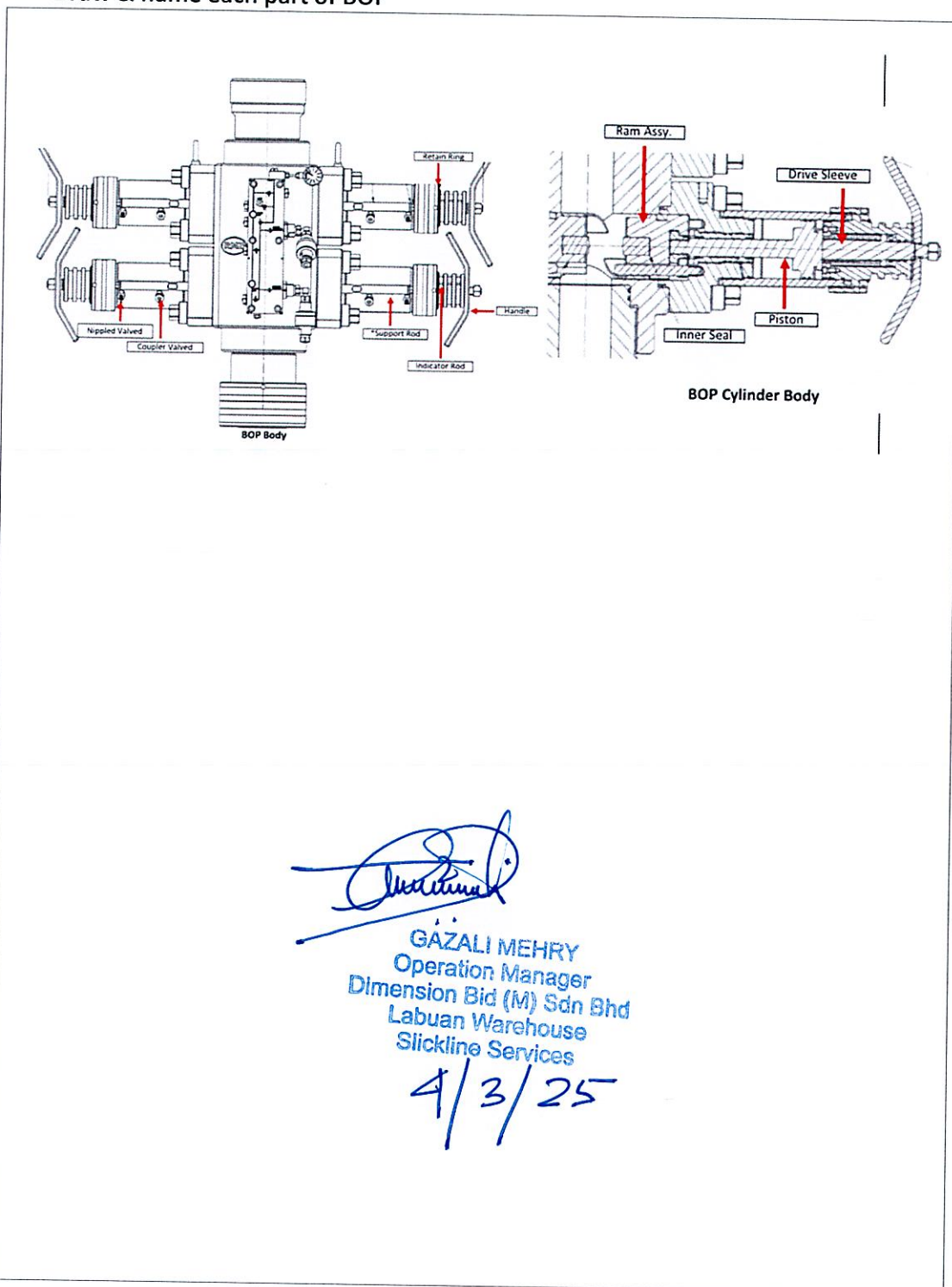

(Handwritten Signature)

GAZALI MEHRY
Operation Manager
Dimension Bid (M) Sdn Bhd
Labuan Warehouse
Slickline Services

4/3/25

B.4. X-MAS TREE

What is x-mas tree

- Xmas tree is a series of valves installed on the wellhead to control the flow of fluids from the well. Located on top of wellhead. ✓

What is the purpose of x-mas tree

- Christmas trees are a vertical group of valves with gauges and chokes that enable injections to increase production and flow control adjustments. ✓

How to operate x-mas tree

- The valves that comprise some of the decorations on the Christmas tree are opened when the oil or gas well is ready to produce and the processing and storage facilities are ready to receive. ✓

What is maintenance required for x-mas tree

- Inspect and replace any damaged component
- Clean X-mas tree and
Do Critical Device Function Test (CDFT) on X-mas tree (check all valves) ✓

GAZALI MEHRY
Operation Manager
Dimension Bid (M) Sdn Bhd
Labuan Warehouse
Slickline Services

4/3/25



What is safety precaution required for x-mas tree

- When you open and close the swab valve, count.
When operating and shutting the valves, avoid overtightening them.
Except in an emergency, never close the flowing well with the master valve.
(use a wing valve or swab.) ✓

What is potential hazard during handling x-mas tree

Pinch point
High pressure
Work under suspended load ✓

GAZALI MEHRY
Operation Manager
Dimension Bid (M) Sdn Bhd
Labuan Warehouse
Slickline Services

4/3/25

Draw & name each part of x-mas tree

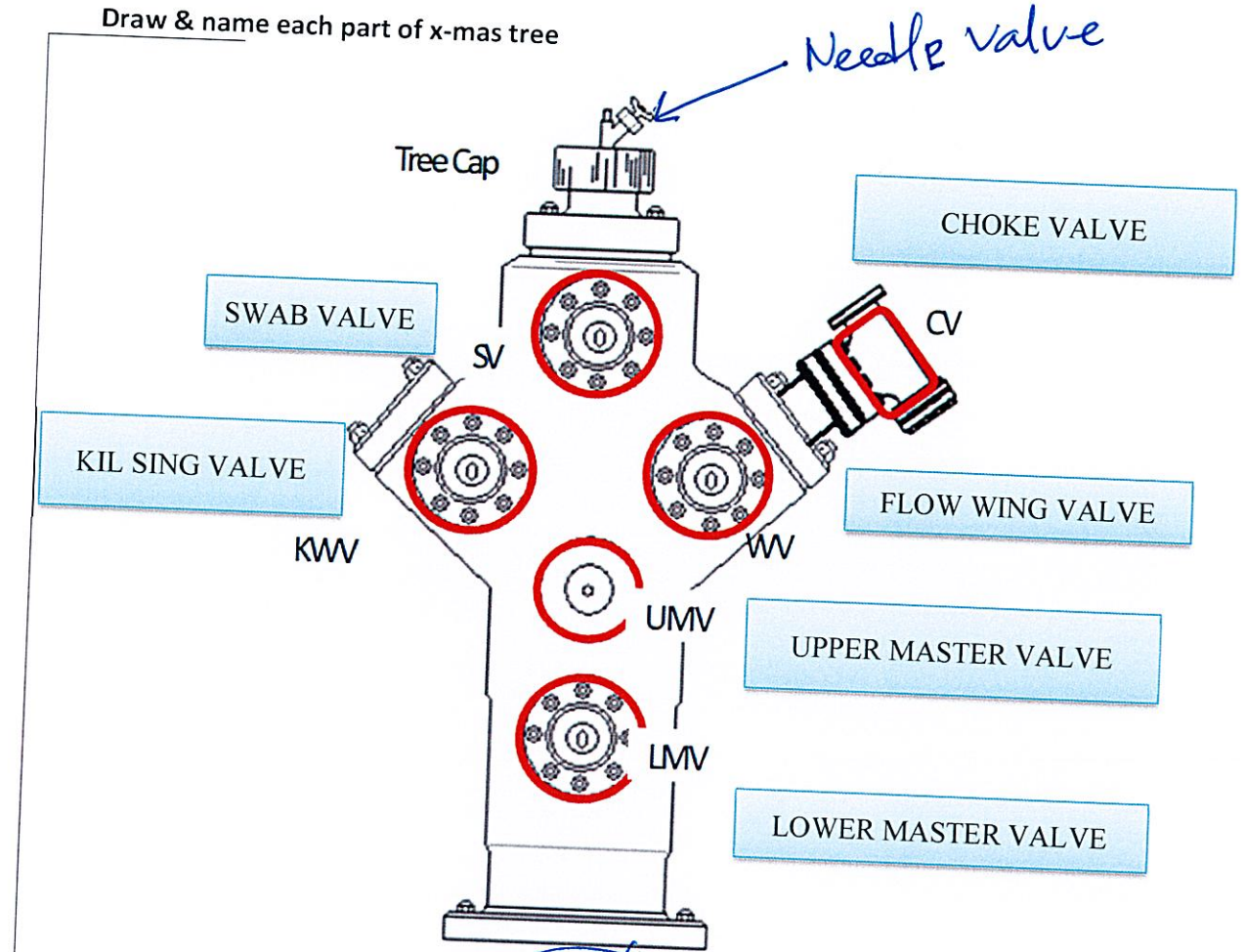

[Signature]
GAZALI MEHRY
Operation Manager
Dimension Bid (M) Sdn Bhd
Labuan Warehouse
Slickline Services

4/3/25

B.5. WIRELINE REEL SKID UNIT (RSU) / WINCH – SINGLE DRUM AND DOUBLE DRUM

What is RSU

- RSU is also known as wireline unit or winch which that can control wireline tool strings to go inside the well or pull the tool strings out of the well.

What is the purpose of RSU

- It is employed to move tools or equipment downhole into and out of wells. In wells that need wireline maintenance, it can rotate the wire drum to raise and lower tool strings.

How to operate RSU

- Using a winch hydraulic system and power pack
Hydraulic hole transmission through the hole between the RSU and power pack

What is maintenance required for RSU

- Check the hand brake system
- Check chain tension
- Gearbox oil

GAZALI MEHRY
Operation Manager
Dimension Bid (M) Sdn Bhd
Labuan Warehouse
Glickline Services

What is safety precaution required for RSU

4/3/25

- When operating, exercise caution around the wire or rotating drum winch as it may break.

What is potential hazard during handling RSU
 Wire breaks off ✓
 Pinch point ✓
 Rotating drum winch ✓

Draw & name each part of RSU

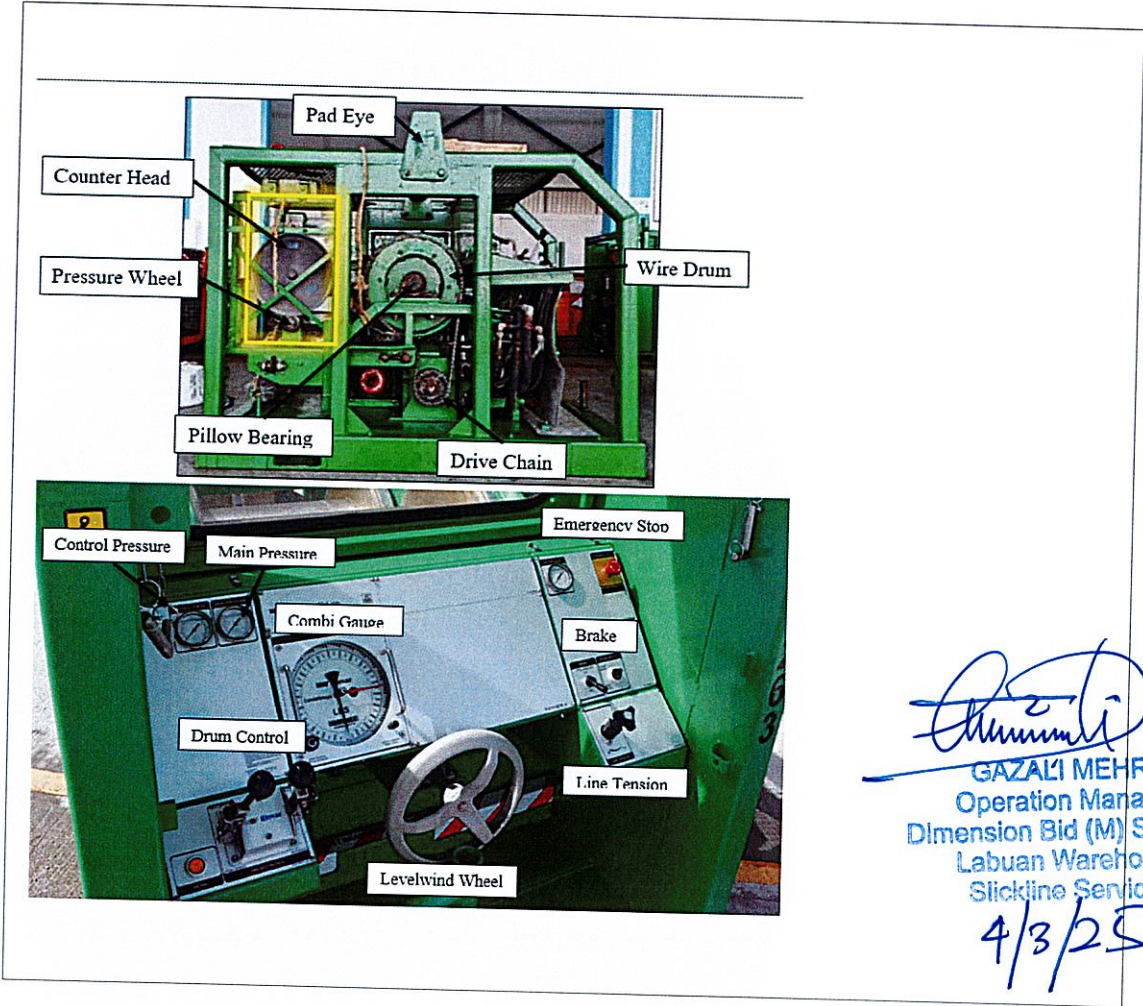

B.6. ODOMETER

What is Odometer

- An odometer, often called a depth counter, is a device used to measure depth. ✓

What is the purpose of Odometer

- to display in feet or meters the depth of the slickline toolstring that is suspended in a tubing string. ✓

How to operate Odometer

- Prior to operation, this device should be manually set to zero and start reading from tubing hanger.
Connect ^{the cable} hose to right angle drive and put odometer to RSU for monitoring purposes. ✓

What is maintenance required for Odometer

- Verify that the counter head may rotate freely.

GAZALI MEHRY
Operation Manager
Dimension Bid (M) Sdn Bhd
Labuan Warehouse
Slickline Services

4/3/25



What is safety precaution required for Odometer

Wear appropriate PPE ✓

What is potential hazard during handling Odometer

Pinch point ✓

Draw & name each part of Odometer

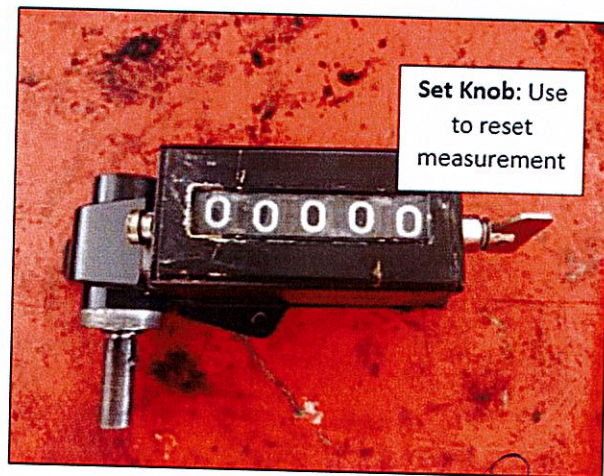

[Signature]
GAZALI MEHRY
Operation Manager
Dimension Bid (M) Sdn Bhd
Labuan Warehouse
Slickline Services

4/3/25

GAZALI MEHRY



B.7. WEIGHT INDICATOR (200 LBS AND 4000 LBS)

What is Weight Indicator

- A tool for determining the weight of tools in tubing string is called a weight indicator. A rubber hose that is filled with hydraulic hose is used to connect the gadget to the load cell.

What is the purpose of Weight Indicator

- To determine the total weight of tools hung in tubing string

How to operate Weight Indicator

- A rubber pipe containing hydraulic oil connects the load cell to the weight indicator, which is situated at RSU. The weight indicator gauge, calibrated in lbs, receives the pressure created by the load cell, which is connected to a sturdy hose. It makes use of a hydraulic system.

What is maintenance required for Weight Indicator

- The device must be fully flushed and recharged at least once every month. A certain distance between the load plate and the load cell retaining ring should be established once the unit has been recharged. Examine the area around the hose and priming check valve assembly for leaks. If more "W-15" fluid is needed, fill it through the little port on the gauge housing's top side.

What is safety precaution required for Weight Indicator

- Do not crash the hose. Secure gauge and fittings because the load cell is made of aluminum alloy and reasonably strong rough handling can damage it.

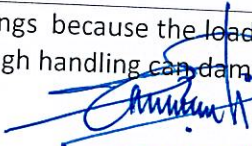
GAZALI MEHRY
Operation Manager
Dimension Bid (M) Sdn Bhd
Labuan Warehouse
Slickline Services

4/3/25



What is potential hazard during handling Weight Indicator

- Drop the item .Failure to pay attention to the weight indication during operation may result in strain and break the wireline.



Draw & name each part of Weight Indicator

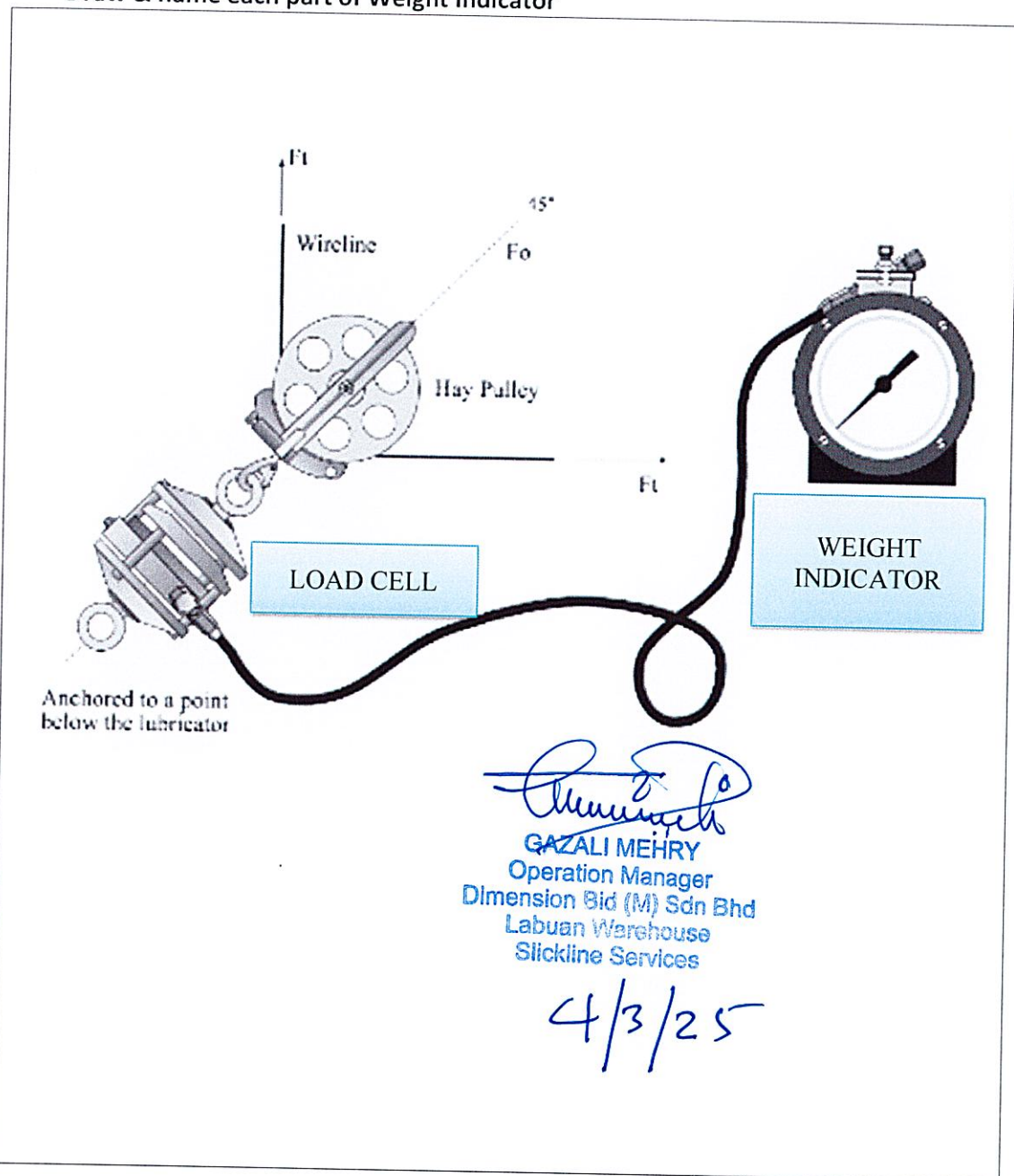

B.8. SPOOLING DEVICE

What is Spooling Device

- Typically, one with a detachable drum that enables the insertion of transport spools so that the fresh string can be spooled into the reel ✓

What is the purpose of Spooling Device

- To hold the reel drum during spooling process
Control the tension of the line as it is spooled ✓

How to operate Spooling Device

- Assemble the reel. The setup is almost the same with normal operation, which weight indicator and hay pulley are needed
Brake level will help to control the line tension. ✓

What is maintenance required for Spooling Device

Brake maintenance, check the hydraulic system ✓

What is safety precaution required for Spooling Device

Make sure to check the glass in good condition before start the job ,Bolts and nuts (shaft) are in good condition ✓

GAZALI MEHRY
Operation Manager
Dimension Bid (M) Sdn Bhd
Labuan Warehouse
Slickline Services

4/3/25



What is potential hazard during handling Spooling Device

Pinch point rotating



Draw & name each part of Spooling Device



GAZALI MEHRY
Operation Manager
Dimension Bid (M) Sdn Bhd
Labuan Warehouse
Slickline Services

4/3/25



B.9. CONTROL PANEL

What is Control Panel

Device used to operate BOP, safety valve and other PCE equipments ✓

What is the purpose of Control Panel

Control Panels are used to operate a number of valves normally operated in slickline operations. Their types and its functions are:

- Control Panel (CP) – To operate BOP rams ✓
- Single Well Control Panel (SWCP) – To operate Master Valve and SCSSV
- Well Control Panel (WCP) – An integrated CP that can operate BOP, Stuffing Box, MV & SCSSV

How to operate Control Panel

Connect the control line to the equipment. Open air supply, use regulator to control pump out pressurized the line. ✓

What is maintenance required for Control Panel

Check the fluid level of hydraulic oil. Check the hydraulic hoses for any sign of leakage or damage ✓

What is safety precaution required for Control Panel

Do not tighten or loose the connection when under pressure. Beware of trapped pressure by bleed off fully before open connection ✓

GAZALI MEHRY
Operation Manager
Dimension Bid (M) Sdn Bhd
Labuan Warehouse
Slickline Services

4/3/25



What is potential hazard during handling Control Panel

Connection loose
Hose burst

Draw & name each part of Control Panel

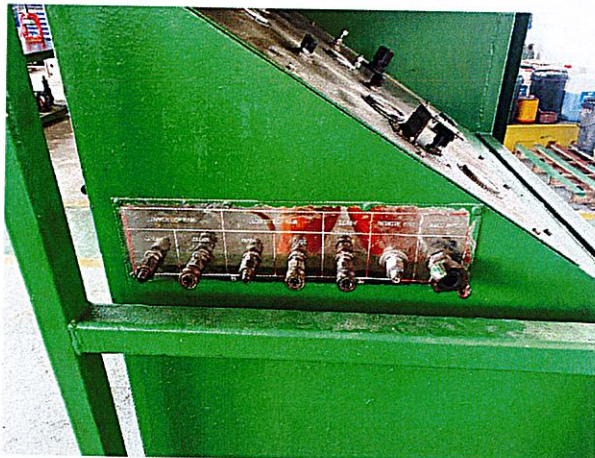
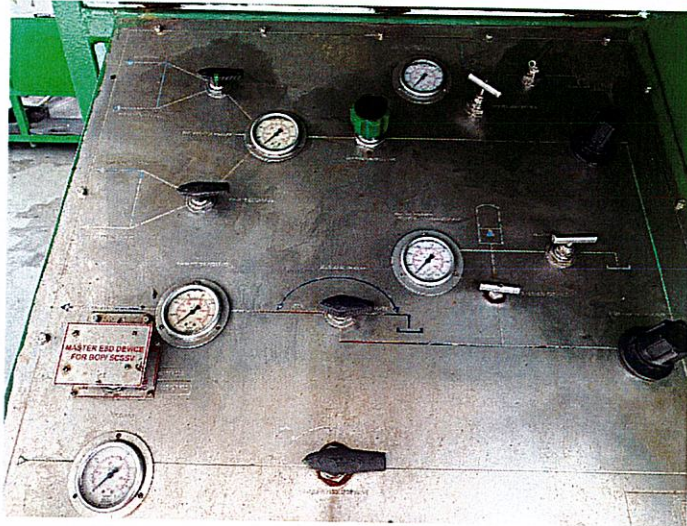

GAZALI MEHRY
Operation Manager
Dimension Bid (M) Sdn Bhd
Labuan Warehouse
Slickline Services
4/3/25



B.10. HUSKEL DRUM

What is Huskel Drum *Pump*

Is an air driver pump .



What is the purpose of Huskel Drum *Pump*

To drive the hydraulic or water in control panel or test pump

How to operate Huskel Drum *Pump*

Operate from the regulator of the panel

What is maintenance required for Huskel Drum *Pump*

- Check the condition of the O-ring
- Service huskel pump
- Hydraulic check valve and liquid seal repair

GAZALI MEHRY
Operation Manager
Dimension Bid (M) Sdn Bhd
Labuan Warehouse
Slickline Services

4/3/25



What is safety precaution required for Huskel Drum

Check O-ring condition. Make sure connection tubing is in good condition



What is potential hazard during handling Huskel Drum

Tubing burst



Draw & name each part of Huskel Drum

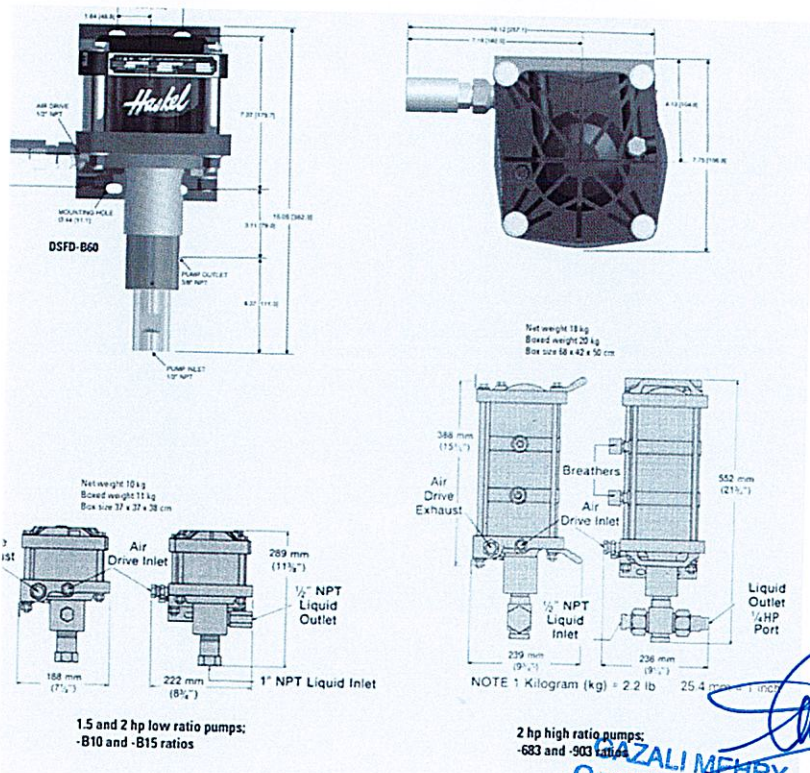

(Signature)
GAZALI MEHRY
Operation Manager
Dimension Bid (M) Sdn Bhd
Labuan Warehouse
Blekkline Services
4/3/25



B.11. POWER PACK (ELECTRICAL & DIESEL)

What is Power Pack

- The diesel engine powers the hydraulically driven power pack. Zone 2 equipment certification

What is the purpose of Power Pack

Provide power to drive hydraulic oil via special hose / hydraulic hose move to drum at winch .Provide the power (hydraulic) to RSU

How to operate Power Pack

- By operating several valves, adjust speed, power and rotation of drum

What is maintenance required for Power Pack

- Check oil level
- Check water level
- Check diesel level
- Check condition of belting
- Check any leaking

GAZALI MEHRY
Operation Manager
Dimension Bid (M) Sdn Bhd
Labuan Warehouse
Slickline Services

9/3/25

What is safety precaution required for Power Pack

- When changing engine or hydraulic oil, use the proper PPE.
- When the engine is operating, watch out for the rotating fan.
- Avoid opening the radiator cap while the power supply is still operating.



What is potential hazard during handling Power Pack

Hose burst
Hand injury
Rotating fan

Draw & name each part of Power Pack

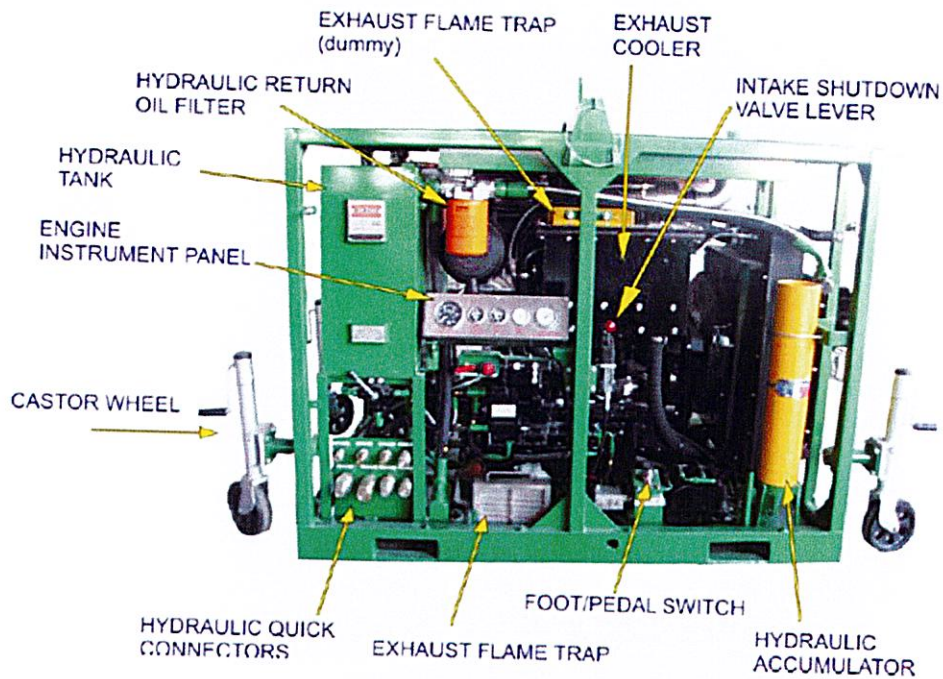

GAZALI MEHRY
Operation Manager
Dimension Bid (M) Sdn Bhd
Labuan Warehouse
Stickline Services

4/3/25



B.12. AIR COMPRESSOR

What is Air Compressor

- A machine that air being compressed driven by diesel engine



What is the purpose of Air Compressor

- To provide compressed air for the air stater engine, test pump, and control panel



How to operate Air Compressor

- The power pack startup process is nearly the same. Typically, spring starters are used in air compressors. Turn the shaft clockwise until the indicator becomes red to start the starter. To start the engine, replace the spring.



What is maintenance required for Air Compressor

- Change filters
- Change oil compressor
- Check fan belting condition



What is safety precaution required for Air Compressor

- Verify that none of the hose connections are leaking. Ensure that the fan is covered.



GAZALI MEHRY
Operation Manager
Dimension Bid (M) Sdn Bhd
Labuan Warehouse
Slickline Services

4/3/25



What is potential hazard during handling Air Compressor

- Hose burst
- Pinch point
- Hot surface



Draw & name each part of Air Compressor

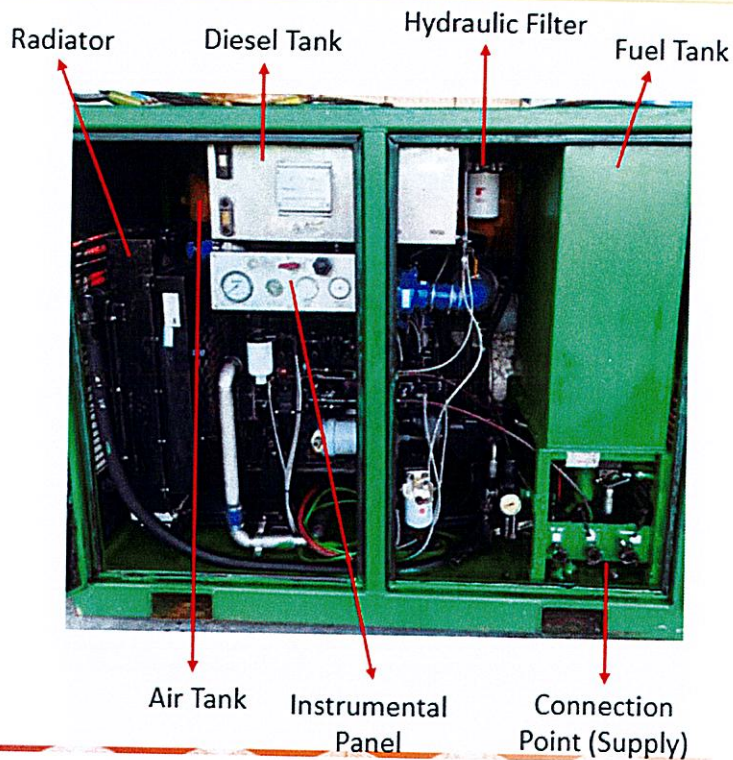



GAZALI MEHRY
Operation Manager
Dimension Bid (M) Sdn Bhd
Labuan Warehouse
Slickline Services
01/31/25

B.13. DRUM

What is the purpose of Drum
To spool the wireline wire

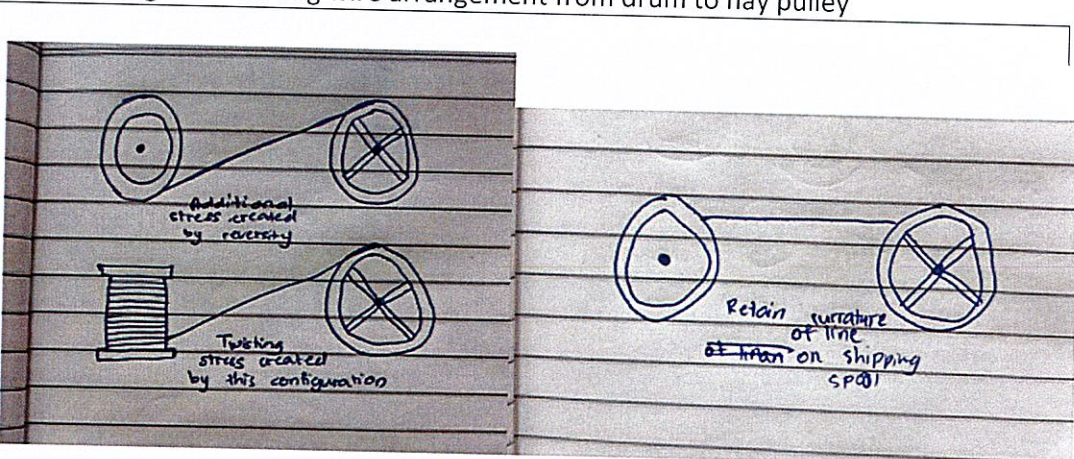
Draw the right and wrong wire arrangement from drum to hay pulley



[Handwritten Signature]
GAZALI MEHRY
Operation Manager
Dimension Bid (M) Sdn Bhd
Labuan Warehouse
Slickline Services

9/3/25

Wrong Method

Right Method



What is maintenance required for Drum

- Always service and inspect the drum bearing, replacing any that are damaged or broken.



What is safety precaution required for Drum

- Use a push-pull stick or tag line. Make sure you're wearing the proper PPE and safety eyewear.



What is potential hazard during handling Drum

Rotating device
Pinch point
Back injury



Please draw/sketch the toolstring configuration for:

- 1) Drift run/tubing clearance check
- 2) Sinker bar run
- 3) Set and retrieve plug
- 4) Set and retrieve insert valve

GAZALI MEHRY
Operation Manager
Dimension Bid (M) Sdn Bhd
Labuan Warehouse
Slickline Services

10/3/25



1. Drift run / robing clearance check (TCC)

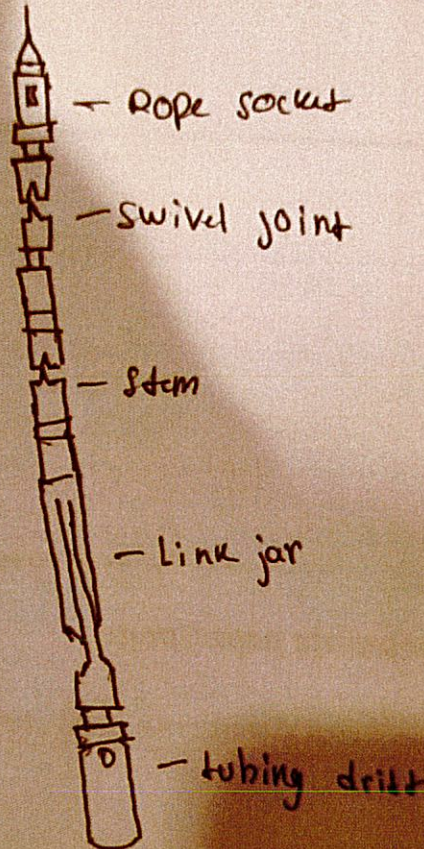

GAZALI MEHRY
Operation Manager
Dimension Bid (M) Sdn Bhd
Labuan Warehouse
24/7 Call Centre Services

4/3/25



2. Sinker bar run

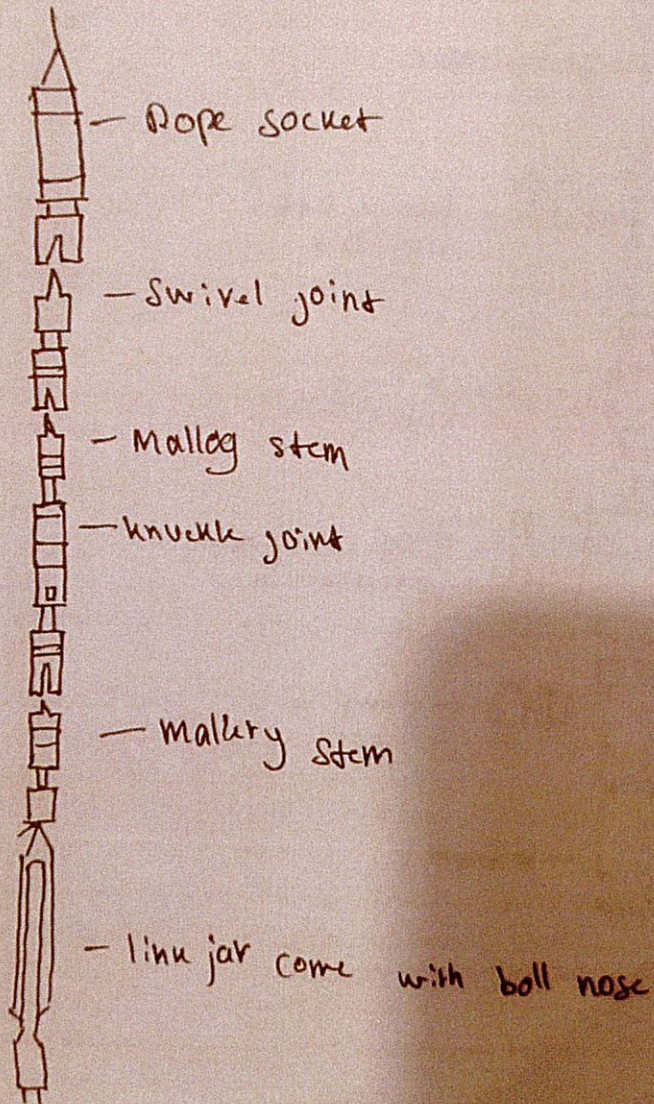

GAZALI MEHRY
Operation Manager
Dimension Bid (M) Sdn Bhd
Labuan Warehouse
Slickline Services

4/3/25



3. Set / Retrieve plug

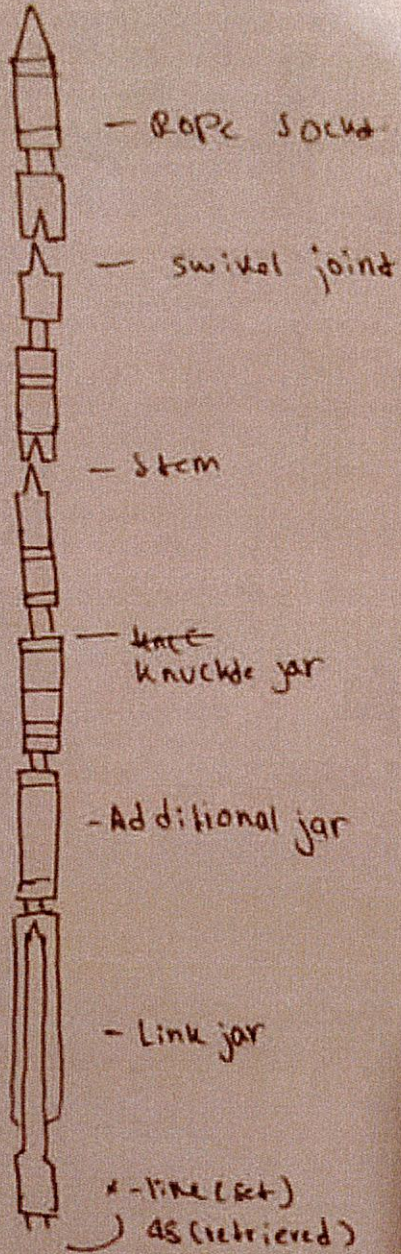



GAZALI MEHRY
Operation Manager
Dimension Bid (M) Sdn Bhd
Labuan Warehouse
Slickline Services

4/3/25

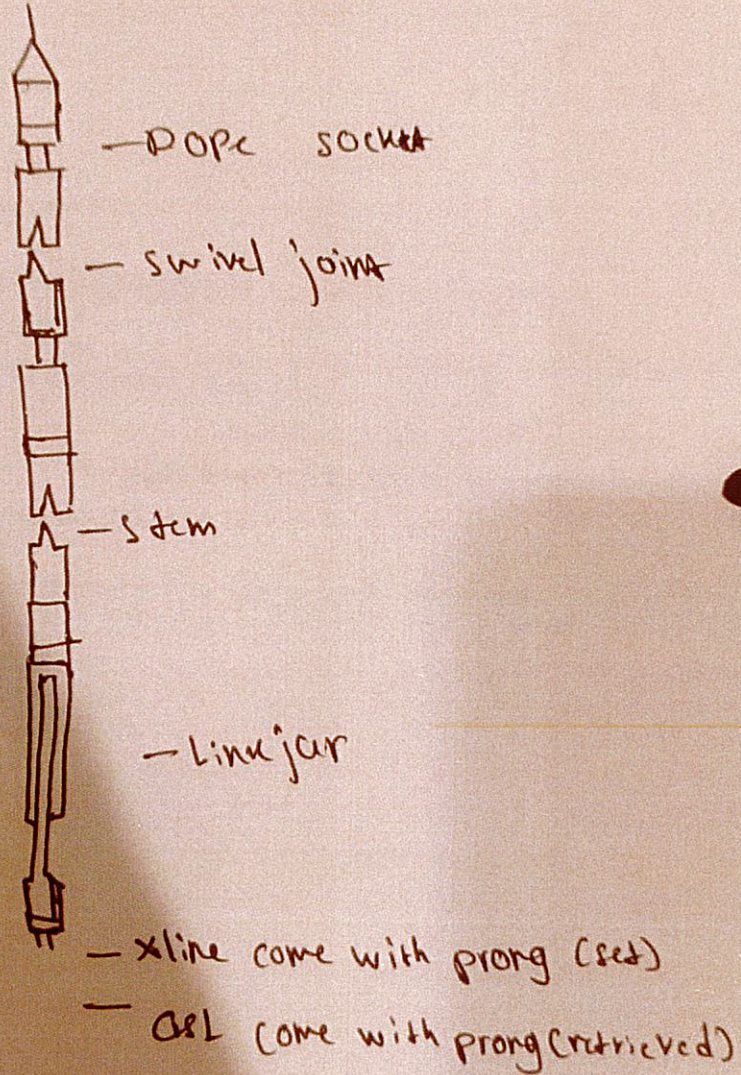

4. Set/Retrieve Insert valve



GAZALI MEHRY
Operation Manager
Dimension Bid (M) Sdn Bhd
Labuan Warehouse
SILKHA SERVICES